

UNOLS Research Vessel Safety Standard (RVSS) Appendix B

June 2023 Ed.



HANDOUTS

- https://drive.google.com/drive/folders/15pl_X8GPA2xhsrHBTdE2y5AqAj6t3Uvx?usp=drive_link

WHAT IS IT?

RVSS Appendix B:

A 10-page document in the back of the UNOLS Research Vessel Safety Standard (RVSS).

Aimed at improving the safety of personnel and gear used to deploy oceanographic instrumentation.

WHERE DID IT COME FROM?

RVSS Appendix B \approx
46 CFR Subpart 189.35



WHAT DOES APPENDIX B APPLY TO?

All Overboard Handling Systems (OHS):

- i. Gear used to lower things below the surface of the water.
- ii. Gear used to drag/tow things in the water.
- iii. Gear that includes a tension member paid out beneath the surface of the water which becomes part of the line pull at the head sheave or winch drum.

OVERBOARD HANDLING SYSTEMS EX. 1

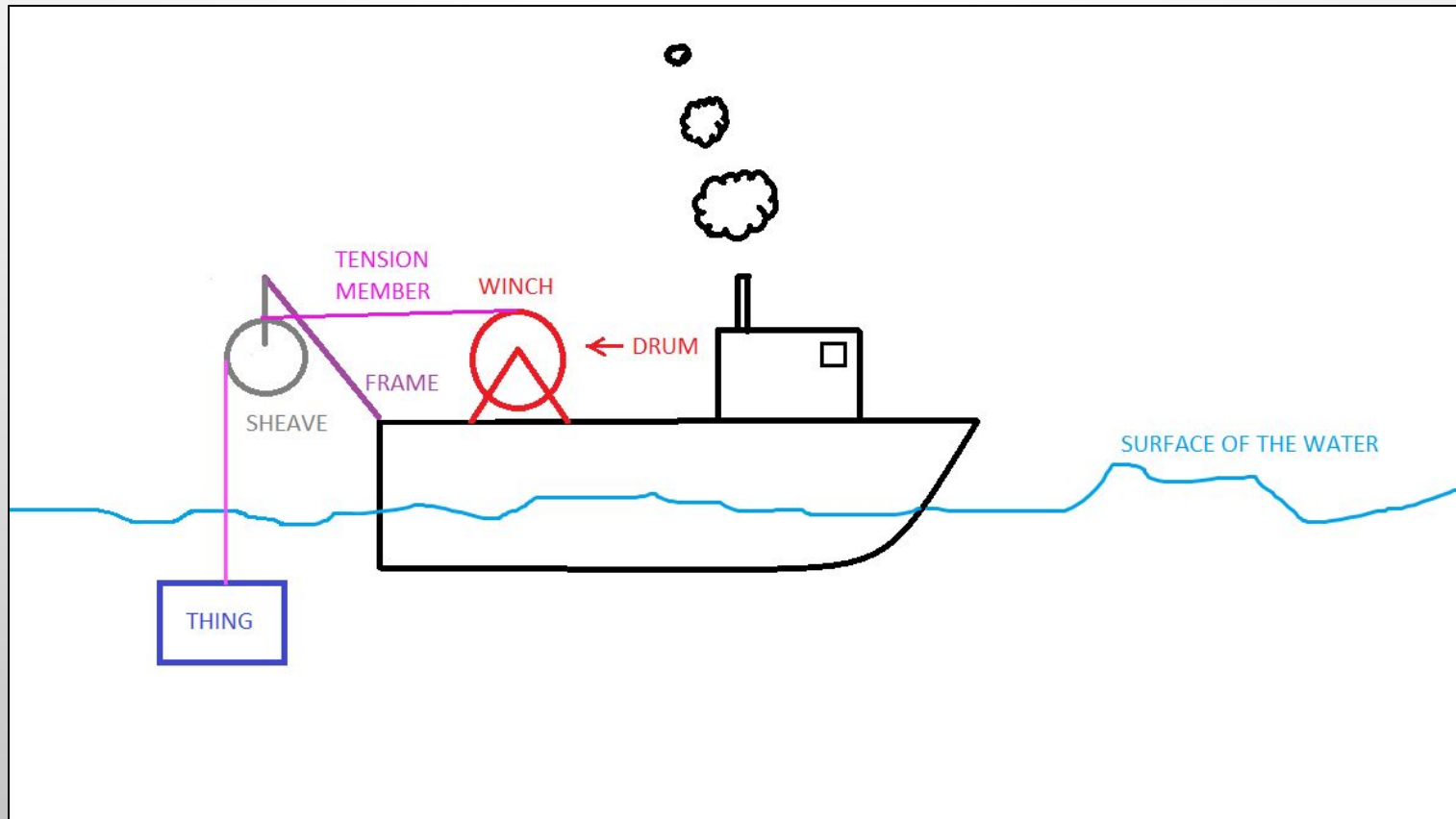

OVERBOARD HANDLING SYSTEMS EX. 2

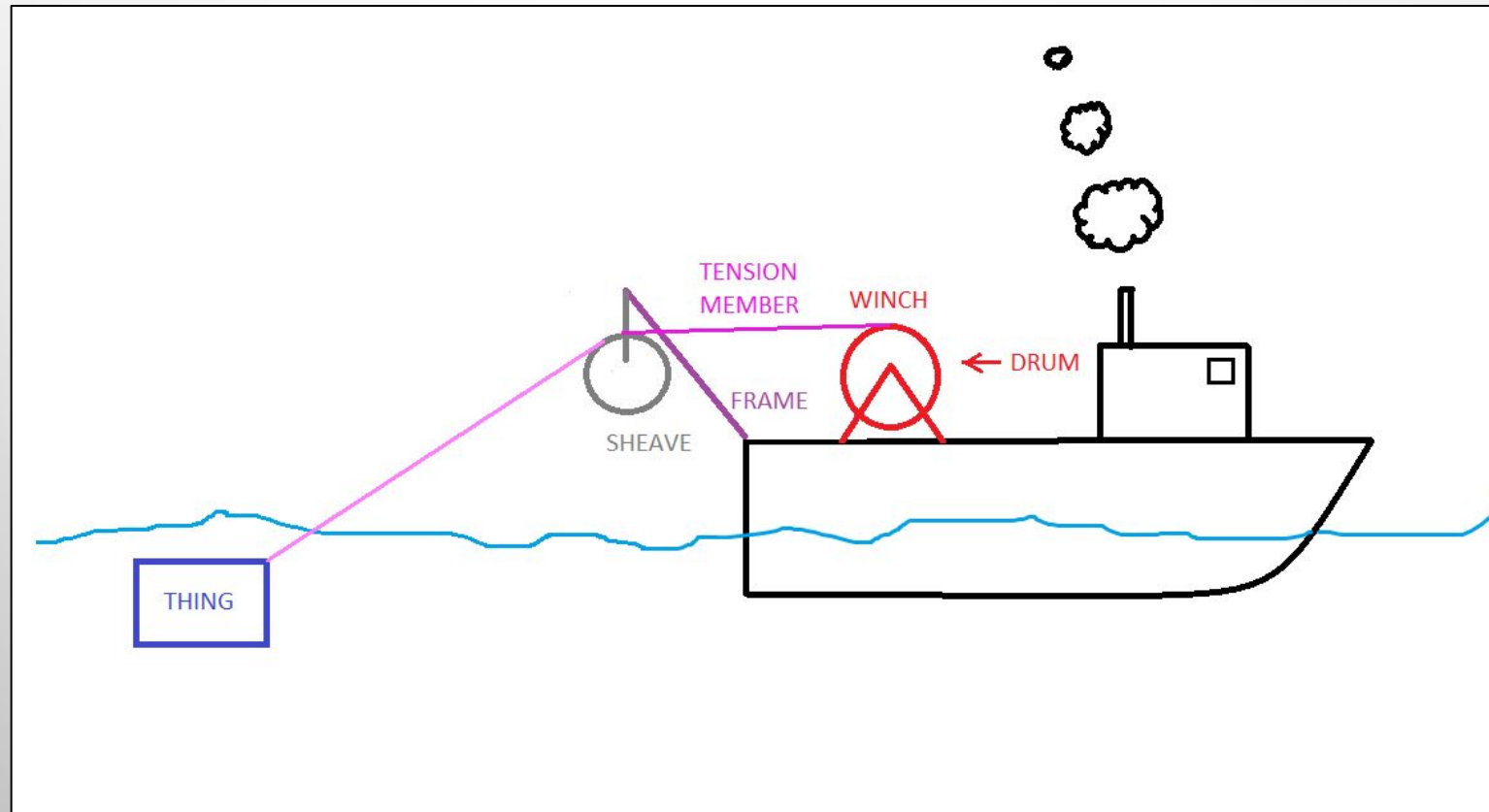

OVERBOARD HANDLING SYSTEMS EX. 3

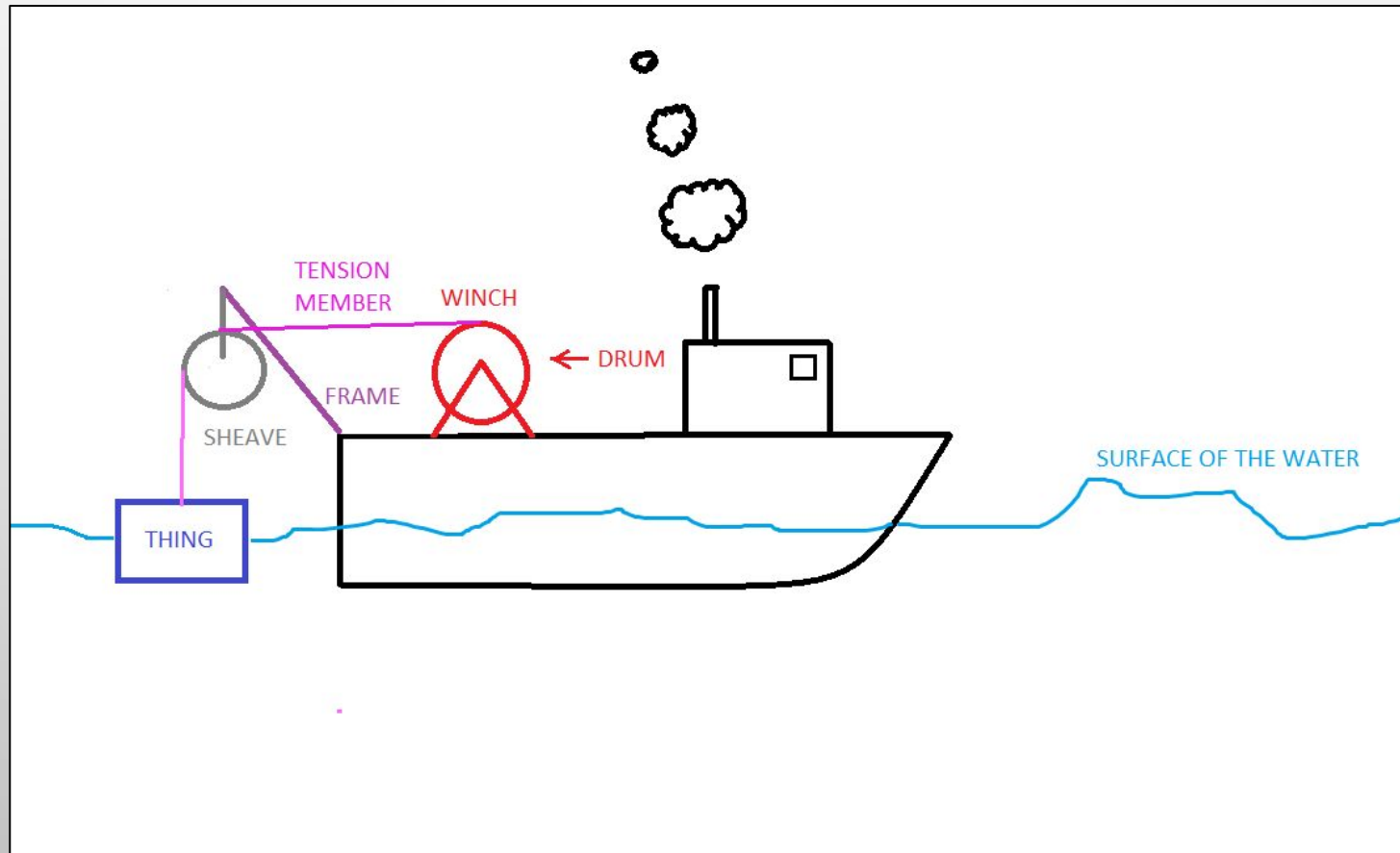

OVERBOARD HANDLING SYSTEMS EX. 4

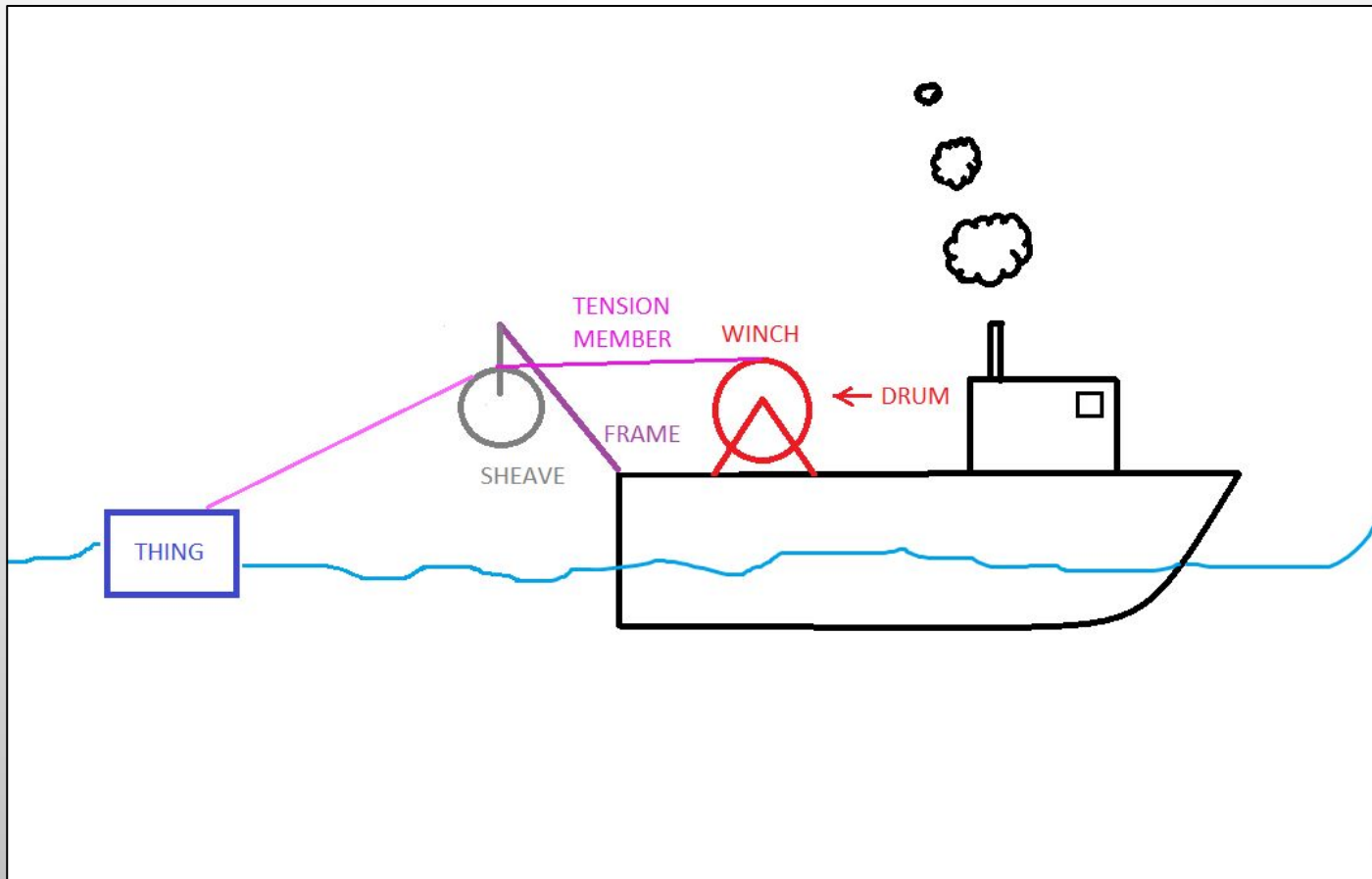

OVERBOARD HANDLING SYSTEMS EX. 5

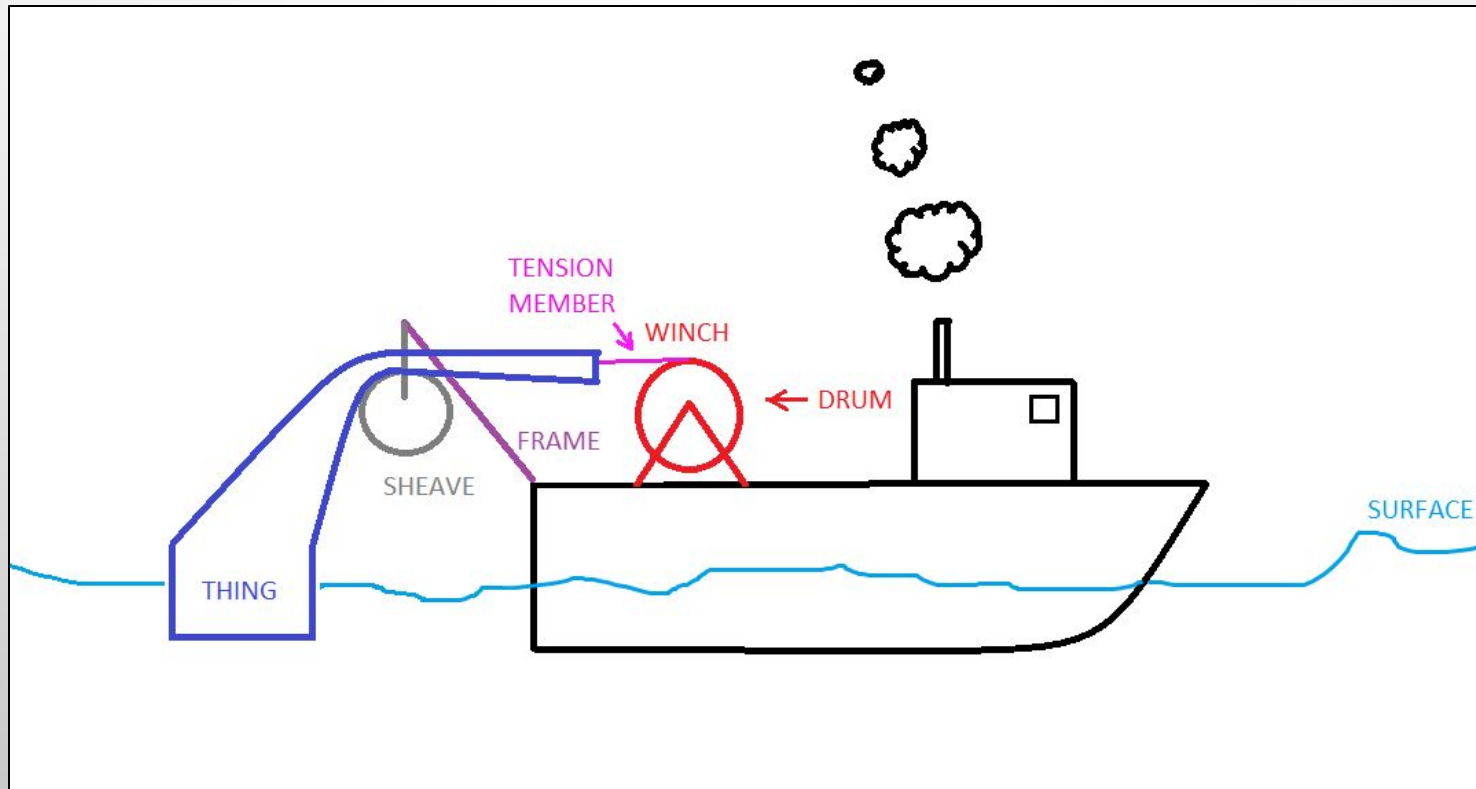

OVERBOARD HANDLING SYSTEMS EX. 6

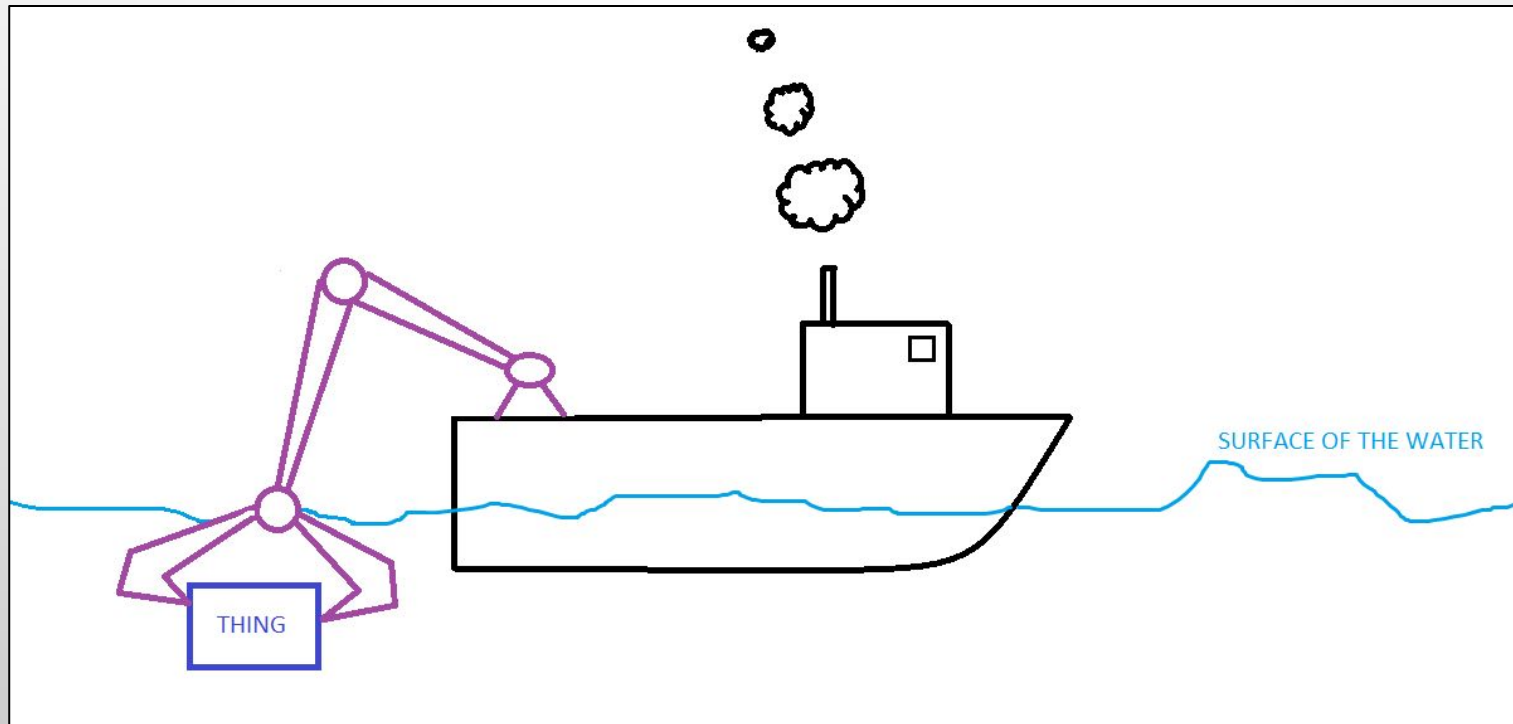

ENTANGLEMENT

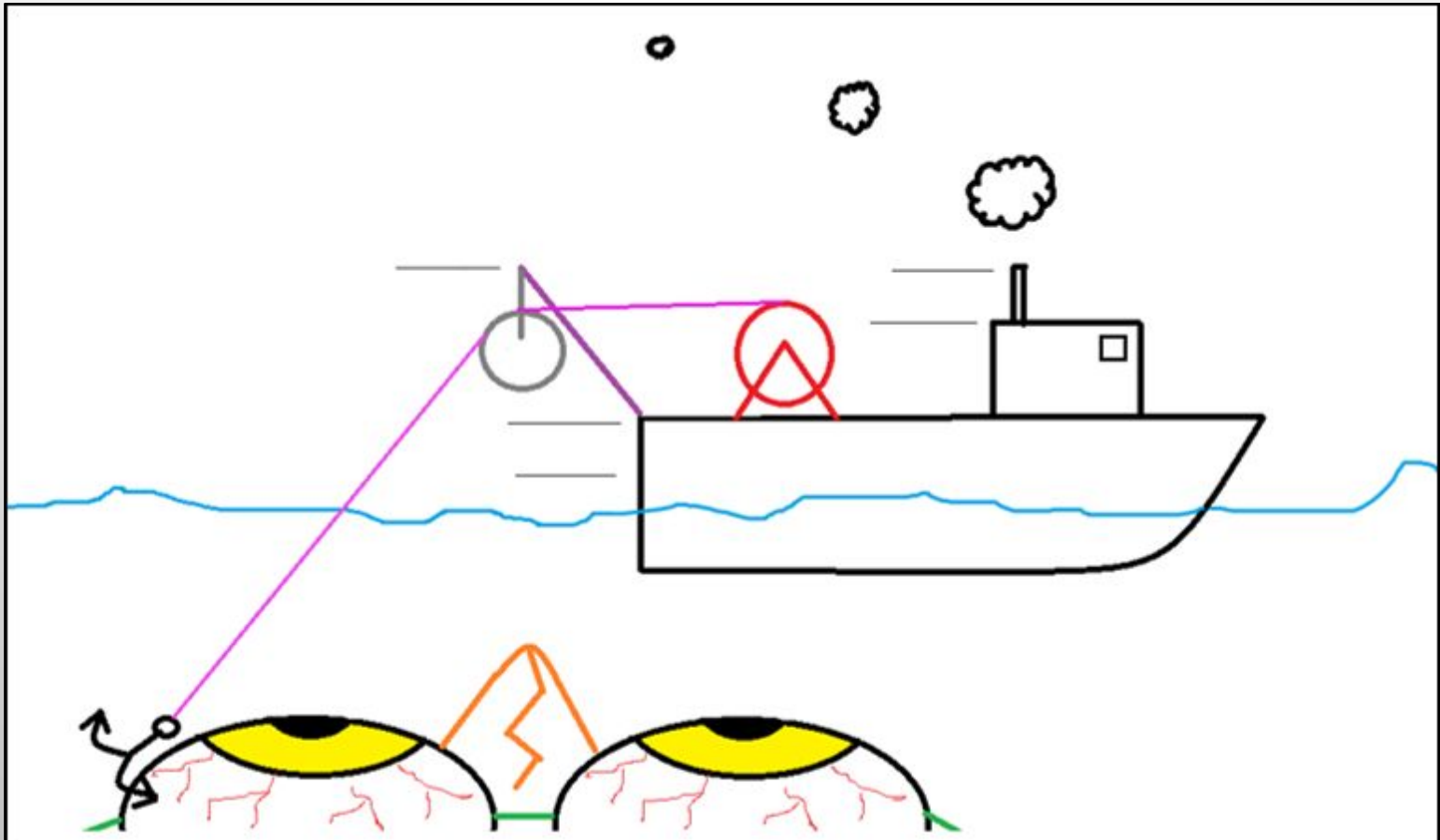

RULES FOR OVERBOARD HANDLING SYSTEMS

- i. How they must be designed (strength, safety features).
- ii. How we must test them.
- iii. How we must label them.
- iv. How we must train people.
- v. How we must document our efforts.

DESIGN RULES

Maximum Stress

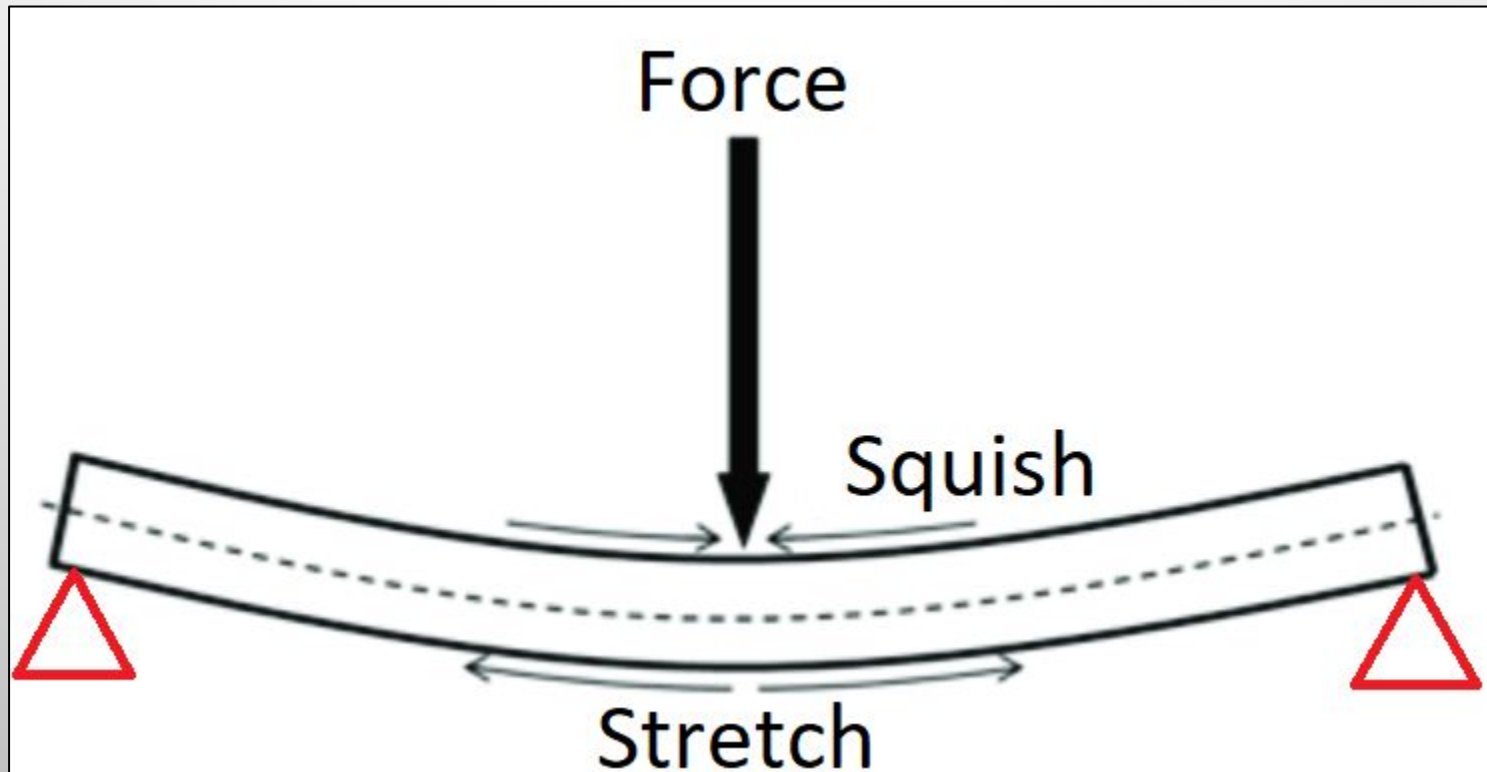

DESIGN RULES

$$\text{Maximum Stress} = \text{Yield Stress} / 1.5$$

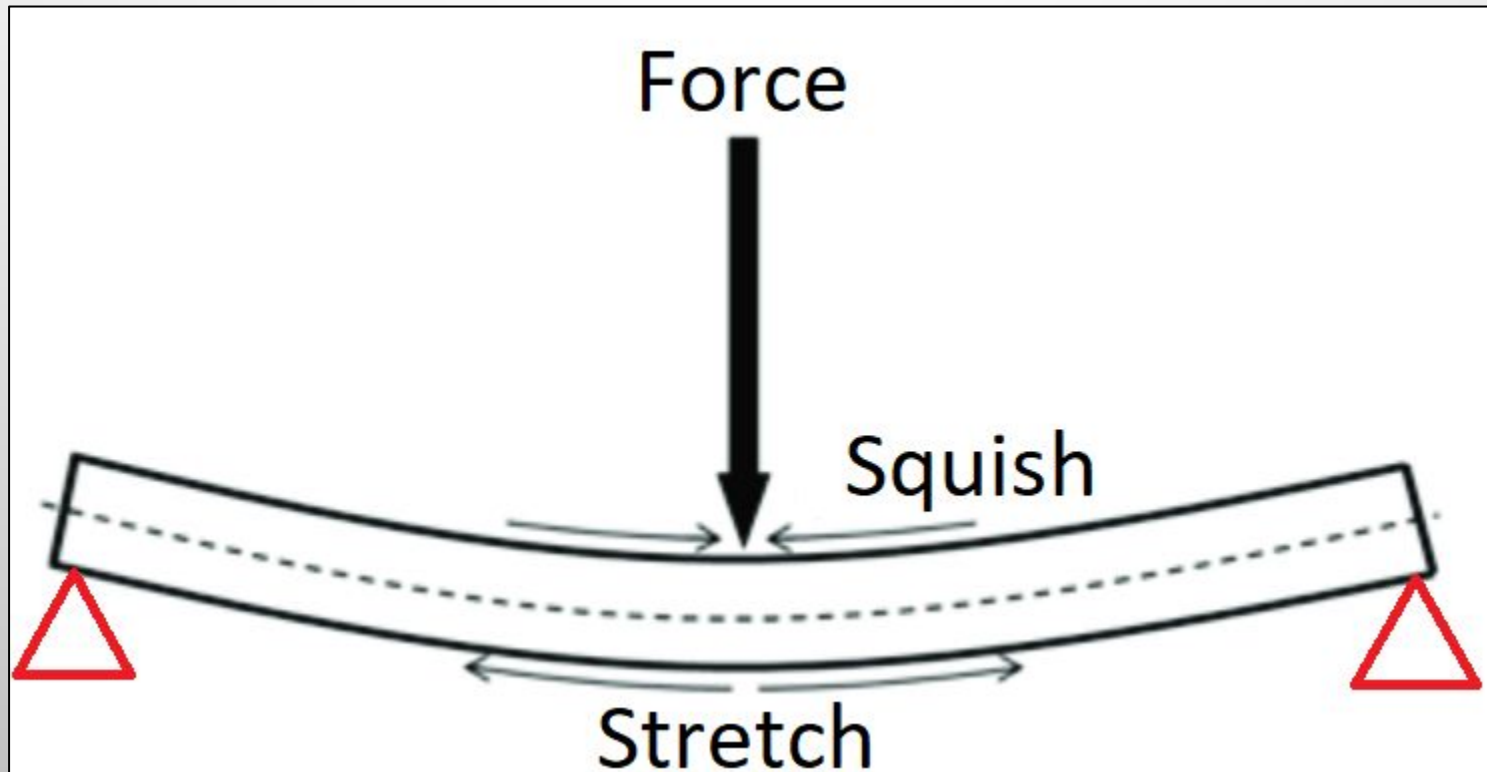

DESIGN RULES

Minimum Strength: Inspected Vessels

For inspected vessels , system components shall be designed, as a minimum, to withstand and operate in excess of the Nominal Breaking Load (NBL) of the strongest tension member used.

DESIGN RULES

Minimum Strength: Uninspected Vessels

Weak links

Torque limiters

Auto-render

DESIGN RULES

Minimum Strength: Direction of Pull

Suitable assumptions for the actual loading conditions shall be used in the design of overboard handling systems. The lead of the wire rope from the head sheave or winch drum shall be considered to vary from the vertical and azimuth in a manner to represent the most adverse loading condition.

DESIGN RULES

Recommended Design Features

- i. Guards
- ii. Signaling Devices
- iii. E-Stops
- iv. Electrical Safeguards
- v. Manual Operating Devices
- vi. Maximum Capability Documents (MCDs)

INSTALLATION

- i. Install IAW manufacturer's instructions.
- ii. Guards must be in place.
- iii. Operational limitations must be posted.
- iv. Don't sink the ship.

TESTING

What, When & Why

- i. Every component must be tested.
- ii. Test each component as its used at sea (except deck hardware).
- iii. Test and assess when new.
- iv. Test every 5 years after that.

INITIAL TESTING & ASSESSMENT

- i. Make sure the system/component looks suitable for what it'll be used for.
- ii. Test each piece, as it's used at sea, to 125% of it's safe working tension.
- iii. Remove all access covers and inspect it.
- iv. Look more deeply if you think you broke it.

PERIODIC TESTING

- i. Every 5 years
- ii. Test each component, as it's used at sea, to 125% of its safe working tension.

TESTING

Testing Deck Hardware

- i. Shackles, pear links, swivels, bolts...
- ii. Inspect for damage
- iii. Ensure the load rating / grade is still visible
- iv. Discard failed hardware

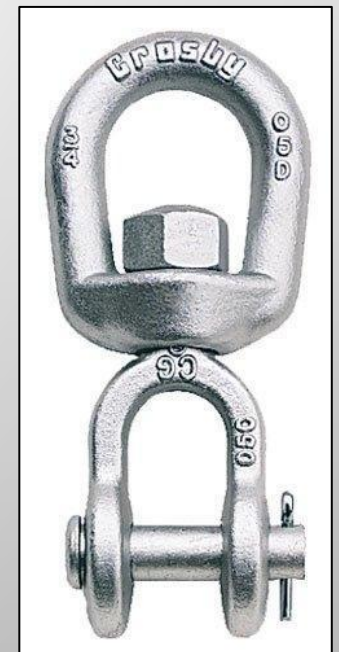
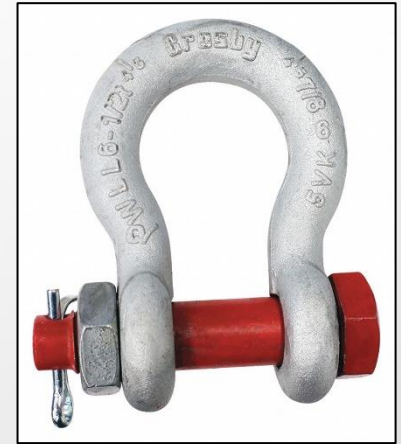
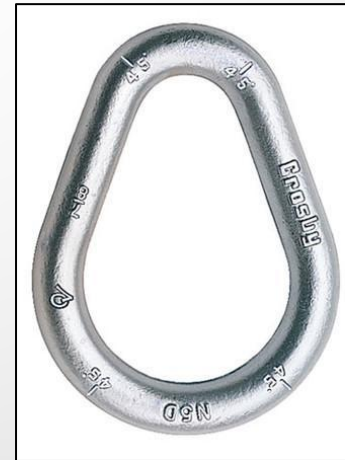

DECK SOCKETS

- i. Only test the ones you use.
- ii. Mark any that are broken.





OHS Test Procedure for R/V Sally Ride

CTD-11V OHS

Revision 9/8/2021_b

Prepared for Scripps Institution of
Oceanography with funding provided by the
National Science Foundation

By

Aaron E. Davis, PE



This document has been prepared to satisfy the requirements set forth in Appendix B of the
UNOLS Research Vessel Safety Standard (RVSS) 11th Edition.

R/V Sally Ride
Load Testing Procedure for the
CTD-11V OHS

1. UNOLS RVSS Appendix B requires OHS be tested to 125% of their SWT every five years.
2. This procedure assumes the NBL of the system's .322" diameter cable is 10,000 lb., the safety factor used with the cable is 2.5, the cable's SWT is 4,000 lb., and the minimum required test load is 125% of the SWT, which is 5,000 lb.
3. In this procedure the test load is 10,000 lb., which is less than the safe working tension of the Allied CTD-11V (11,100 lb.) stbd. side handling unit, the Markey CAST-6-125 winch (12,000 lb.), and the Smith Berger 322 guide sheave (16,000 lb.).
4. Verify the Dynamometer that will be used is properly calibrated.
5. Verify the winch's tension meter is properly calibrated.
6. Disable the winch's RENDER/RECOVER function.
7. Remove the termination from the CTD cable if required to completely haul it in.
8. Haul in the CTD cable completely.
9. Reeve a length (about 110 ft.) of 3/8" diameter Samson Amsteel®-Blue line (minimum spliced breaking 17,600 lb.) through the OHS with a spliced eye on it's working end. This will be the test line.
10. Lash the test line to the bitter end of the CTD cable.
11. Haul in the test line until there are 10 or more wraps on the winch drum.
12. Attach the Dynamometer to the spliced eye on the test line.
13. Attach the water bag to the dynamometer.
14. Place the side handling unit in the cast and towing position. Pay out the line as required to keep the dynamometer well below the handling unit.
15. Ensure the jib is completely retracted and within the limits shown in Figure 1 (following page). Ensure it remains that way throughout the test.
16. Ensure the water bag is in the proper position for the test, i.e., clear of the side handling unit, the vessel, and not above anything that might be damaged if the OHS or bag should fail.
17. Slowly fill the water bag until the dynamometer indicates 10,000 lb. Check for agreement between the dynamometer and the winch's tension meter as the bag is filling.

18. Wait 5 or more minutes. Inspect the systems for signs of failure while you wait.
19. Release the water from the water bag.
20. Remove the test line from the system.
21. Put the winch's RENDER/RECOVER function in the same state it was in before this test was conducted.
22. Let the vessel master and the winch and wire engineer know when the test is complete so they can make note of it in the appropriate vessel logs, NS5, and in the UNOLS wire pool database.
23. Give the test line to the winch and wire engineer, who will inspect it, keep track of the number of tests it's used for, have it tested, and discard.

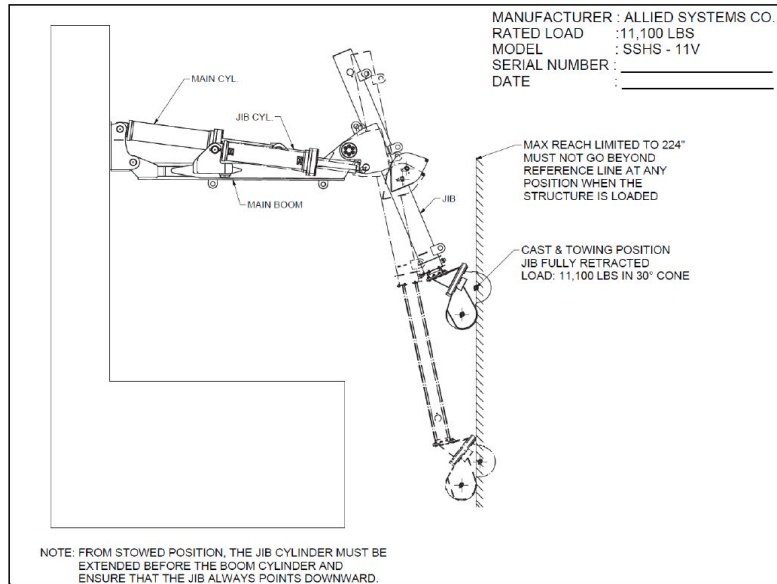
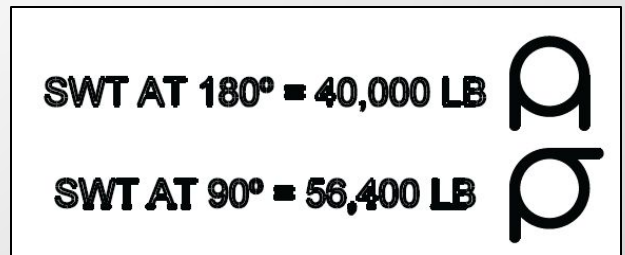

Figure 1: Limitations on the rated load of the CTD-11V (figure 4-2 in its technical manual). Note it's rated load of 11,100 lb. assumes the jib is fully retracted and no further than 224" from its base. Extending the jib or orienting it beyond these limits during this test may cause damage to the system.



LABELING

- i. Test date
- ii. The safe working tension (SWT)
- iii. A diagram (if possible)



(Deck hardware only)

- i. Strength / grade markings
- ii. Indicate they've been inspected recently

LOGS

- i. Test date
- ii. The test method (a written procedure)
- iii. The names of those involved
- iv. Also make entries whenever gear is inspected, repaired, or experiences a casualty

TRAINING

- i. A formal training program is required
- ii. All operators must complete the program
- iii. Refresher training is required annually
- iv. The program must include auditable records

MCD

Maximum Capability Documents

- i. Safe Working Tension (SWT)
- ii. Design Line Tension (DLT)
- iii. Reaction Forces



Smith Berger Marine, Inc.

7915 10th Avenue South • Seattle, WA 98108-4404 • USA

Maximum Capability Document for

Model 22-N Hanging Block

This document describes the Maximum Capabilities of a Smith Berger Model 22-N Hanging Snatch Block. The Block is configured with a 22.0" OD Nylatron sheave grooved for .322" diameter E-M cable and rotating on tapered roller bearings. The bearings are greased through a fitting provided on the end of the sheave shaft.

Following is a Capabilities Table and a Load Diagram for Model 22-N Hanging Snatch Block

Item	Maximum Capability
Safe Working Tension (SWT)	11,500 Lbs.
Design Line Tension (DLT)	11,500 Lbs.
Factor of Safety	1.5
Wire Groove Diameter	.322 in.
Sheave Root Diameter	18.0 in.
Maximum Wrap Angle	180 degree
Minimum Wrap Angle	10 degree
Maximum Sheave Speed	100 Rev./ Min.
F_{max}	23,000 Lbs.

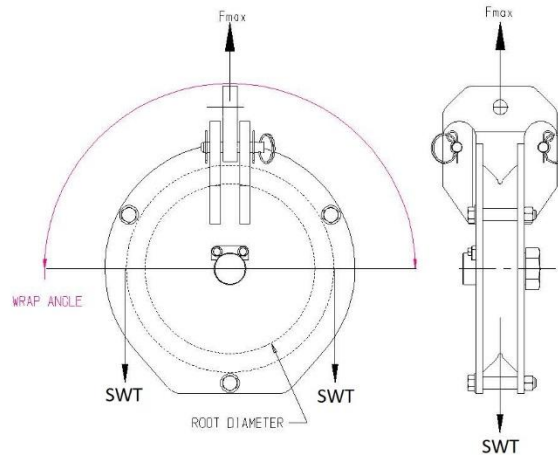

Prepared by: P. Pasero

Date: 1/25/13

Revision: 0

OHS OPERATOR'S MANUALS

- i. A detailed description of the OHS layout
- ii. OHS test procedures
- iii. Procedural safety requirements
- iv. Operator training procedures
- v. References to component manuals/data sheets
- vi. Maintenance procedures

APPENDIX B ASSIST SHEETS

OHS CHECKLIST
REV 6-17-22

OHS NAME			
Requirement	Reference	Y / N / N/A	Comment
COMPONENT DESIGN			
The OHS is designed to withstand and operate in excess of the Design Line Tension (DLT).	B.2		
For inspected vessels, the DLT is the nominal breaking load (NBL) of the strongest tension member used.	B.2		
For uninspected vessels, the DLT is either the NBL of the tension member or the maximum tension when a load limiting device is used.	B.2		
(i.e., the yield strength of the material is at least 1.5 times the calculated stresses resulting from application of a load equal to the DLT.)	B.2		
Substantive assumptions for the actual loading conditions were used in the design of the component. The lead of the wire rope from the head sheave or winch drum were considered to vary from the vertical land in azimuth in a manner to represent the most adverse conditions.	B.2		
For uninspected vessels, load limiting devices are designed to prevent a load exceeding the DLT autonomously.	B.2.1		
For uninspected vessels, weak links are used to prevent the tension at the head sheave from exceeding the DLT. They are of a calibrated design.	B.2.1.1		
For uninspected vessels, auto-render causes the winch to pay out in order to prevent the DLT from being exceeded. The winch does not free spool, but rather automatically pays out, in a controlled fashion, then resumes its previous operating state.	B.2.1.2		
For uninspected vessels, a torque limiter limits the maximum torque applied to a drum. It is calibrated. It is designed specifically for this purpose. It operates in this manner without damage. It doesn't free spooling and automatically resets to an opeable state after an over torque event. It is either a torque-limiting coupler with automatic reset, a relief valve, a brake, or an electronic motor torque control.	B.2.1.3		
Guards are installed to prevent personnel injuries for rotating equipment, pinch points, cable runs, and other hazards or at other appropriate locations.	B.2.2.1 B.3.1		
Signaling devices are installed and setup to warn personnel of unexpected startup, especially when equipment may be operated automatically or is operated remotely.	B.2.2.2		
Accessible e-stops are placed at all operator stations as well as locally to the equipment, when equipment may pose a hazard to personnel.	B.2.2.3		
Electrical safeguards are in place to accommodate lock out/tag out procedures.	B.2.2.4		
The OHS has either a fused disconnect or circuit breaker.	B.2.2.4		
Manual operating devices require constant operator intervention.	B.2.2.5		
The OHS has dead man style controls (i.e. spring-centered joysticks, no friction locks).	B.2.2.5		

* == A recommendation, not a requirement
 **==A recommendation for uninspected vessels, but required on inspected vessels.
 ***=Not required for systems combining portable and fixed equipment.

COMPONENT CHECKLIST
REV 6-17-22

COMPONENT NAME			
Requirement	Reference	Y / N / N/A	Comment
COMPONENT DESIGN			
The component is designed to withstand and operate in excess of the Design Line Tension (DLT).	B.2		
For inspected vessels, the DLT is the nominal breaking load (NBL) of the strongest tension member used.	B.2		
For uninspected vessels, the DLT is either the NBL of the tension member or the maximum tension when a load limiting device is used.	B.2		
(i.e., the yield strength of the material is at least 1.5 times the calculated stresses resulting from application of a load equal to the DLT.)	B.2		
Substantive assumptions for the actual loading conditions were used in the design of the component. The lead of the wire rope from the head sheave or winch drum were considered to vary from the vertical land in azimuth in a manner to represent the most adverse conditions.	B.2		
For uninspected vessels, load limiting devices are designed to prevent a load exceeding the DLT autonomously.	B.2.1		
For uninspected vessels, weak links are used to prevent the tension at the head sheave from exceeding the DLT. They are of a calibrated design.	B.2.1.1		
For uninspected vessels, auto-render causes the winch to pay out in order to prevent the DLT from being exceeded. The winch does not free spool, but rather automatically pays out, in a controlled fashion, then resumes its previous operating state.	B.2.1.2		
For uninspected vessels, a torque limiter limits the maximum torque applied to a drum. It is calibrated. It is designed specifically for this purpose. It operates in this manner without damage. It doesn't free spooling and automatically resets to an opeable state after an over torque event. It is either a torque-limiting coupler with automatic reset, a relief valve, a brake, or an electronic motor torque control.	B.2.1.3		
Guards are installed to prevent personnel injuries for rotating equipment, pinch points, cable runs, and other hazards or at other appropriate locations.	B.2.2.1 B.3.1		
Signaling devices are installed and setup to warn personnel of unexpected startup, especially when equipment may be operated automatically or is operated remotely.	B.2.2.2		
Accessible e-stops are placed at all operator stations as well as locally to the equipment, when equipment may pose a hazard to personnel.	B.2.2.3		
Electrical safeguards are in place to accommodate lock out/tag out procedures.	B.2.2.4		
The component has either a fused disconnect or circuit breaker.	B.2.2.4		
Manual operating devices require constant operator intervention.	B.2.2.5		
The component has dead man style controls (i.e. spring-centered joysticks, no friction locks).	B.2.2.5		

* == A recommendation, not a requirement
 **==A recommendation for uninspected vessels, but required on inspected vessels.
 ***=Not required for systems combining portable and fixed equipment.

CONTACT US

Capt. Heather Galiher, Manager

(858) 534-5568

hegaliher@ucsd.edu

Aaron E. Davis, PE, Engineer

(619) 251-6368

aed001@ucsd.edu

#NSF WINCH POOL

