

## A Scientists Guide to AUV *Sentry* Cruise Planning and Proposal Writing

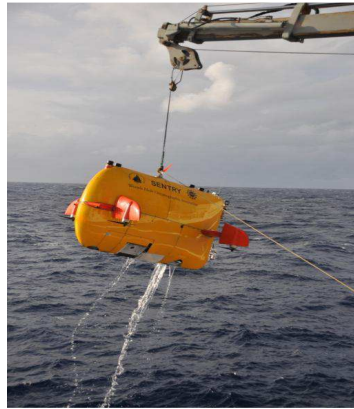

Figure 1 - AUV *Sentry*

### Introduction

This guide is intended to provide you with the basics of planning a *Sentry* dive or expedition. It is not intended to be and cannot be a complete reference (in part because we pride ourselves on trying new things to solve your problems). As always we encourage early and frequent interaction. We are more than happy to, indeed prefer to, be involved and aware even as you write your proposal. Many people and resources exist to assist you, but two key points of contact for you are the *Sentry* Project Manager and the Chief Scientist for Deep Submergence. Due to frequent travel schedules, contacting both Carl Kaiser and Adam Soule is recommended. As soon as they are contacted they will pull in whatever other resources are necessary to meet your needs.



**Dr. Carl Kaiser**  
***Sentry* Project Manager**  
**Woods Oceanographic Institution**  
[ckaiser@whoi.edu](mailto:ckaiser@whoi.edu)  
p. +1.508.289.3269  
m. +1.970.217.1328



**Dr. Adam Soule**  
**Chief Scientist for Deep Submergence**  
**Woods Hole Oceanographic Institution**  
[asoule@whoi.edu](mailto:asoule@whoi.edu)  
p. +1 508 289 3213

## **General Philosophy**

*Sentry* is a part of the National Deep Submergence Facility which means that it is a national asset for the use of the scientific community at large. To this end, *Sentry* spends a lot of time at sea for various scientists. In 2014 she is expected to spend over 175 days at sea all over the world for five different cruises. *Sentry* is a fly away system meaning that it can be integrated into a wide variety of ships (see Appendix C – Ship Selection Guidelines) including UNOLS, private, and foreign vessels and can move rapidly around the world in two 20ft ISO containers by road, sea, or air freight. We aim to be a mostly turn-key solution providing a vehicle, staffing, planning, and substantial data processing (see Appendix A – Data) as a part of the facility.

## **Custom work and Innovation**

*Sentry* operations are about a 70/30 split of the routine to the innovative. In other words, we have quite a few basic survey types that serve many of our science user's needs. On the other hand, we love to work with you to develop new techniques as well. This frequently includes integration of experimental or custom sensors, development of new survey patterns, adaptive survey techniques, joint operations with other vehicles, etc. We do some development, customization, or integration for nearly every cruise, larger changes or additions may require more planning and either a separate proposal or a community consensus of the need for the capability, but we are happy to pursue any of these routes with you. Many of us have robotics research careers in addition to our role with the facility.

## **Planning**

Cruise planning is essential to successful operations. We love to hear from you early, the earlier the better. Often we can help you to craft your proposals to make the best use of *Sentry*, even if the best use is off the beaten path. Once your proposal is funded and your cruise is schedule, we will kick off a planning process (see Before Your Cruise) where we like to understand your goals, needs, and plans. Typically providing us with a copy of your proposal is helpful. There will be several types of data that you need to provide to us ahead of the cruise as well.

While planning is key, we do not recommend pre-planning individual missions prior to the cruise. These nearly always change frequently for a wide variety of reasons and are nearly as difficult to re-plan as to plan in the first place.

## **Suggestions for This Document**

This document is meant to provide you with as much information as possible about proposals, cruises, and data. We don't always know what you need and want so if you find something missing, please drop us an e-mail and we'll both answer your questions and try to add the info here.

## **Table of Contents**

Introduction .....	1
General Philosophy .....	2
Custom work and Innovation .....	2
Planning .....	2
Suggestions for This Document.....	2
Table of Contents .....	3
The Vehicle: Specs and Sensors .....	8
The Basics.....	8
Sensors.....	9
Navigation Equipment .....	9
Internal Navigation .....	10
External Navigation.....	10
The Crew .....	10
Expedition Leader .....	11
Deck Coordinator.....	11
Before Your Cruise.....	12
Initial Call .....	12
Primary Cruise Planning Meeting.....	12
Your Expedition Leader.....	12
Points of Contact .....	12
Critical Things We Need from You.....	12
Mob and Demob .....	13
Time Requirements .....	13
Port Facilities and Equipment .....	13
What We Will Need From You .....	13
Cruise and Survey Planning.....	14
Joint Operations with Other vehicles and Assets.....	14
Navigation and Monitoring of <i>Sentry</i> .....	14
Tracking and Air Traffic Control.....	14
Dredges, CTDs, Towcam Etc .....	14
ROVs.....	14
Human Occupied Vehicles .....	15
Weather Windows and Considerations.....	15
Principles for Weather Decisions.....	15

Typical Weather Limits.....	16
Survey Types .....	16
High Coverage Multibeam .....	16
Maximum Resolution Multibeam.....	17
Wide Area Sidescan .....	17
High Res Sidescan with Photo Strips.....	17
Dense photo coverage .....	17
Sparse photo coverage .....	18
Dive Durations .....	18
Turn Arounds.....	18
Crew Rest .....	20
Partial dives, 24 hour cycle:.....	20
Full dives, reduced speed, 48 hour cycle: .....	20
Blackout Window:.....	20
Data and Data Handover .....	21
Data Formatting .....	21
Additional Copies.....	21
Archival .....	21
Appendix A – Data.....	22
Data Collected .....	22
Scientific Sensor Data .....	22
Multibeam Echo Sounder Data.....	22
Interferometric Bathymetry, Sidescan Sonar, and Sub-Bottom Profiler .....	22
Digital Still Camera.....	22
Eh Sensor .....	23
CTD Data.....	23
Magnetometer.....	23
Optical Backscatter .....	23
Dissolved Oxygen.....	23
Sensors of Opportunity .....	23
Command and Control Data.....	23
Navigation Data .....	23
Doppler Velocity Log Data.....	23
Inertial Navigation and Gyro Data .....	23
Topside USBL Data.....	24

Topside Navigation Estimation Program Data and Logs .....	24
Subsea Navigation Estimation Program Data and Logs .....	24
Post Processing.....	24
Initial Data Ingestion.....	25
Navigation Processing (Renavigation) .....	26
Chemical, Geophysical and Physical Oceanography Data.....	28
Bathymetric Data.....	28
Water Column Multibeam: .....	29
Photographs .....	30
Chemical and Physical Oceanography Data .....	30
Sidescan and Sub-bottom .....	30
Data Products .....	31
Delimited ASCII Navigation and Sensor File (SCC) .....	32
Navigation and Sensor Plots.....	33
Navigated Matlab Binary Files.....	34
Bathymetric Maps .....	34
Sidescan Waterfall Plots.....	36
Sub Bottom Strip Charts.....	37
Photographic Products.....	38
Custom Data.....	39
Nascent Data Products .....	39
Water Column Multibeam: .....	40
Sidescan Mosaics .....	40
Fledermaus Visualizations.....	42
Blueview Imaging Sonar.....	42
Timeliness of Data Delivery.....	42
Organization of Delivered Data.....	42
Appendix B – Sensor Details .....	43
Sidescan Sonar and Sub Bottom Profiler .....	43
SBP Sonar Resolution, Range and Penetration .....	43
SSS Sonar Resolution and Range .....	45
System Specifications.....	47
Appendix C – Ship Selection Guidelines .....	48
Basics .....	48
Details .....	48

Ship Propulsion Requirements .....	48
Deck Space: .....	48
Lab Space .....	51
Storage Space .....	52
Ships data .....	52
GPS .....	52
Gyro.....	52
USBL/LBL .....	53
Berthing.....	54
Ships Equipment and Services.....	55
Crew Assistance.....	55
Crane, Rigging & Handling Requirements:.....	55
Internet .....	56
Previous Vessels .....	56
Appendix C – Launch and Recovery Procedures.....	57
LAUNCH AND RECOVERY PREPARATION .....	57
General Safety Awareness .....	57
On Deck Personnel.....	57
Personal Protective Equipment.....	58
NORMAL OPERATING CONDITIONS.....	58
Vessel Setup .....	58
<i>Sentry</i> Launch .....	58
<i>Sentry</i> Recovery .....	59
Launch and Recovery Pictures and Sequence.....	60
Launch.....	60
Appendix D – Points of Contact and Resources .....	65
<i>Sentry</i> Project Manager.....	65
Chief Scientist for Deep Submergence .....	65
.....	65
NDSF Operations Manager.....	65
Appendix E – Pre Cruise Questionnaire and Checklist .....	66
Data You Need to Provide.....	66
Data to be Handed to You.....	66
Sensors You Will Need.....	66
Appendix F – Sea Going Staff .....	67

Appendix G - Acoustic Devices: Frequencies & Power .....	68
Appendix H – Dive Weights.....	69
Sentry Descent Weights.....	69
Sentry Ascent Weights.....	70
Navigation Mooring Anchors .....	71
Appendix I – Organization of Delivered Data.....	72
At-Sea Processed Data Products - Products Directory.....	72
Raw and Intermediate Data - Dives Directory.....	73

## The Vehicle: Specs and Sensors

### The Basics

*Sentry* is a 6km Autonomous Underwater Vehicle (AUV) designed for extreme mobility. To date it has completed more than 190 dives from 14 different vessels. *Sentry* is typically used for systematic survey, but is also capable of more adaptive missions in some cases.

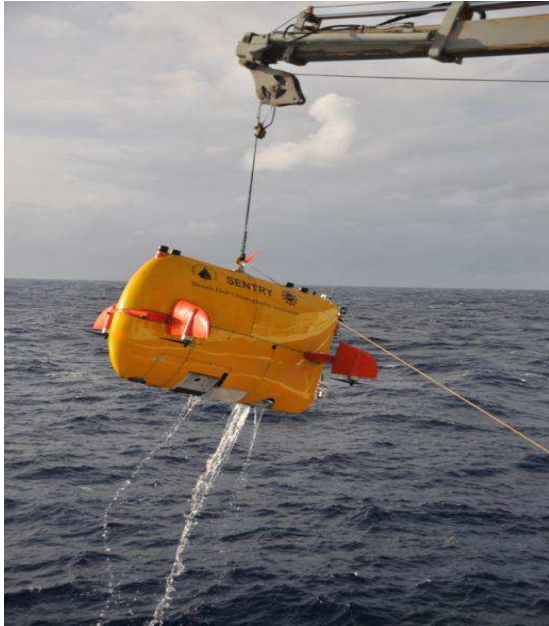

**Figure 2 - AUV *Sentry***

Depth capability	6,000 meters
Dimensions: Length:	2.9m (9.7ft)
Width	2.2m (7.2ft)
Height	2m (6.5ft)
Weight:	1,451 kg (3,200 lb) without extra science gear
Operating range	70-100 km, (38-54 mile) depending on speed, terrain and payload
Operating speed	0-1.2 m/s (0-2.3 knots)
Propulsion	:4 brushless DC electric thrusters on pivoting wings
Energy	Lithium Ion batteries; 13 kWh
Bus power	48-52 Volts DC.
Endurance	18-40 hours depending on mission type
Recharge time	10 hours, 16 hour full turnaround from surface to release
Descent/Ascent speed	40m/min for both descent and ascent, 2400m/hr.
Navigation	USBL Navigation with real-time Acoustic Communications and/or Long Baseline (LBL) using acoustic transponders, Doppler Velocity Log (DVL), and Inertial Navigation System (INS)

**Figure 3 - Basic Specifications for *Sentry***



## Sensors

*Sentry* is typically equipped with a number of standard sensors (Figure 4). In addition we regularly integrate custom sensors owned by the PIs or in some cases (e.g. Ko-Ichi Nakamura's eh probe) loaned from other sources. Selected previously integrated sensors are given in Figure 6.

Sensor	Model
Sonardyne Ranger 2 w/ Avtrack2	Ranger 2
WHOI LBL	Custom
INS	IXSEA PHINS 1 INS
DVL	RDI 300kHz
Pressure Depth Sensor	Paroscientific 8B7000
CTD	SBE FastCAT 49
Dissolved Oxygen	Aanderaa Optode w/ fast foil
Turbidity	Seapoint Optical Back Scatter (OBS)
Side Scan Sonar	Edgetech 2200-M 120/410kHz
Sub Bottom Profiler	Edgetech 2200-M 4-24kHz
Magnetometers	3x APS1520 3 axis
Camera	Prosilica GC-1380C Digital Still Camera
Multibeam	Reson 7125 MBES 400kHz with 7216 receiver

Figure 4 - Standard *Sentry* Sensors

WHOI maintains other sensors which may be available on *Sentry* at little or no additional cost. These sensors are listed in [Figure 5]. These sensors are used on projects in addition to *Sentry* so if you have an interest, please contact us well in advance.

Sensor	Owner
Edgetech 850kHz Dynamic Focus Sidescan	
Blueview P900 forward looking imaging sonar	

Figure 5 - Additional WHOI owned sensors that may be available for use on *Sentry*

Sensor	Owner
Tethys Mass Spectrometer	Dr. Richard Camilli - WHOI
Chelsea Aquatraka	Dr. Richard Camilli – WHOI
3-D Image Reconstruction System	Dr. Oscar Pizzaro – Australian Center for Field Robotics
Eh Probe	Dr. Ko-ichi Nokamura
MAPR	Sharon Walker – NOAA PMEL
ORP Sensor	Sharon Walker – NOAA PMEL
SUPR microbial and larval filter sampler	Dr. Chip Beier – WHOI

Figure 6 - Selected Custom Sensors Previously Used on *Sentry*. These require either collaborative agreements with the owners or incur additional cost or both.

## Navigation Equipment

*Sentry* requires both internal and external navigation. The internal navigation is sufficient to navigate the vehicle for quite a while; depending on terrain between a couple hours and a full dive. However the external navigation is required to reset the internal fix after descent and periodically throughout the dive. Final navigation is post processed using proprietary code and will be delivered in a variety of formats as described in Appendix A – Data.

### Internal Navigation

The internal navigation is dead reckoning based on the Inertial Navigation System (INS) and Doppler Velocity Log (DVL) sonar system. It has a typical accuracy of 0.1% of distance traveled. It does sometimes struggle with bare volcanic rock or very steep terrain requiring more frequent external updates. The internal navigation is not effective during ascent or descent and is only minimally effective if the vehicle is not within 200m of the bottom. This requires much more frequent updates from an external solution.

### External Navigation.

*Sentry* navigates using either Ultra Short Baseline (USBL) or Long Baseline (LBL) navigation. As a practical matter we nearly always use USBL and if you have any plans to use LBL we will need to know well in advance. USBL requires 8-12 hours early in the cruise and then no further calibration or survey is required for the remainder of the cruise. Typically the vessel must be within 1 water depth (closer in very deep water) after descent and every 4-6 hours on bottom for this to be fully effective. More frequent coverage will be more effective.

LBL requires the placement and survey of subsea transponders. These have the advantage of not requiring the close presence of the vessel more than occasionally for a health check, but require 8-12 hours each to deploy survey and recover. They must be reset and resurveyed in each area and typically three are needed in any given area. An area is approximately 5x5km. We will still need to check on the vehicle occasionally as described in Navigation and Monitoring of *Sentry*.

### **The Crew**

The at sea complement for *Sentry* is five people with one of those slots generally intended for a trainee who will nonetheless be needed to fill critical roles while at sea. *Sentry* operations groups are convened on a cruise by cruise basis under the constraint of filling all of the roles below and allowing for either a trainee or significant cross training.

1. Mission Planner & Data Processor
  - a. Creates mission plans consistent with collecting data requested by science.
  - b. Advises science on appropriate/optimal use of the vehicle for their data goals
  - c. Processes vehicle navigation
  - d. Processes raw vehicle data into deliverable described in the *Sentry* Data Products Document
2. It should be noted that this is a more sophisticated position than a traditional data processor role that would be seen in *Alvin* or *Jason*. The nature of the data products coming from *Sentry* (Multi-beam, sidescan, etc) requires significant judgment and experience for optimal results. In addition *Sentry* often integrates specific sensors or makes cruise specific customizations that require adjustment of the tool chain and hence familiarity with the code base. Systems Engineer
  - a. Primary responsibility to make sure that the entire vehicle system is functional. Coordinates efforts of mechanical and electrical engineers to this end
  - b. Maintains vehicle software and makes any cruise specific changes required
  - c. Leads all pre and post dive activities and has ultimate responsibility for checklists
  - d. Assists in data processing as time allows
3. Mechanical Engineer
  - a. Responsibility for maintaining the mechanical readiness of the vehicle at all times
  - b. Performs all of the routine and scheduled maintenance required by the vehicle

- c. Carries out any required mechanical repairs
- 4. Electrical Engineer
  - a. Responsibility for maintaining the electrical readiness of the vehicle at all times
  - b. Carries out an required electrical repairs
  - c. Maintains and charges batteries
- 5. Trainee (may be an experienced person learning a new role or task or a new person)
  - a. Watch Standing responsibilities
  - b. Training related duties as assigned by the Expedition Leader and the AUV Operations Manager

It should be noted that roles may be (and usually are) rotated around, split up, or otherwise reconfigured by the Expedition Leader for operational or training reasons.

In addition to the core vehicle roles, all members of the group have watch standing duties, launch and recovery assignments, and cross training goals.

Two additional roles are required to be assigned among the four core vehicle personnel, expedition leader and deck boss.

#### Expedition Leader

**Overall responsibility for the safety of the personnel and the vehicle. Has final decision making authority for all decisions affecting either of these.**

- Oversees personnel and responsibilities both to ensure that all work is complete but also to ensure that no one becomes overworked to the point of endangering people or equipment.
- Coordinates with Science party and ships crew on all aspects of *Sentry* operations to ensure a successful cruise. (Parts of the coordination may be delegated, for example, the Deck Operations person will nearly always be the point of contact into the vehicle for the Bosun or Deck boss from the ship)
- Ensures that science deliverables are provided to the science party in a timely fashion and that any deliverables not finished by the end of a trip due to extenuating circumstances have a clear plan for being finished that is also communicated to the group manager.
- Responsible for the cruise report or for making sure that others are designated to complete appropriate sections
- Sends daily updates to interested parties in a format TBD.

#### Deck Coordinator

- In conjunction with the ship's Bosun's responsible for safety of people and vehicle during deck ops
- Develop launch and recovery plans in conjunction with the ship's crew
- Oversees outside portion of launch checklist – may or may not personally perform the tasks
- Sets up all rigging
- Coordinates position and timing of vehicle, people, equipment during launch and recovery
- Coordinates raising and lowering of USBL system and develops plan for the same

## **Before Your Cruise**

### **Initial Call**

Once your cruise is officially scheduled, we will set up a brief phone call to discuss the goals, needs, and circumstances of your cruise in case there are significant issues that need to be addressed well ahead of time. If we have been discussing prior to the proposal, this may not be necessary.

### **Primary Cruise Planning Meeting**

Typically two to four months before your cruise, the vessel operator will have a cruise planning meeting. NDSF personnel will be a part of this meeting and will discuss specifics of mob, demob, data products, data needs, etc. At this point you will also be introduced to your expedition leader.

### **Your Expedition Leader**

Your Expedition Leader will be your primary point of contact with the *Sentry* group both in the final run up to the cruise and once you are at sea. The expedition leader may or may not be writing the actual mission plans (most of the time they will be) but they will be responsible for all of the logistics and timing of the *Sentry* vehicle. They are there to make your cruise as successful as possible and if there are things that you require or concerns that you have, talk to them early and often.

In addition to making your cruise as successful as possible, the Expedition Leader also ultimate responsibility for the safety of all of the *Sentry* personnel and equipment. In the event of difficulties such as weather or malfunction, the Expedition leader will work closely with you and the Captain to develop plans and make decisions about the ability to operate. At the end of the day, if the Expedition Leader decides that the vehicle cannot safely dive at a particular time or place due to weather, malfunction, staffing, bottom hazards etc. that decision will be final and will not be questioned from shore.

### **Points of Contact**

Technical questions should be addressed to the Vehicle Manager; logistics questions should be addressed to the Logistics Manager. Once an expedition leader has been assigned, please include him or her in all correspondence.

### **Critical Things We Need from You**

In order to have a successful cruise, there are a number of things that we need from you. The two most critical are information about any custom sensors you want to integrate and ship based bathymetry in an appropriate format for the dive site. There is a full checklist/questionnaire in Appendix E – Pre Cruise Questionnaire and Checklist.

## **Mob and Demob**

### **Time Requirements**

On a typical UNOLS vessel, *Sentry* can be mobilized in 2 days and demobilized in 1 day. These do not include the day of sailing or the day of return to port. The vessel and crane must be available first thing in the morning on the day of mobilization.

On non-UNOLS vessels or vessels where we cannot install at least one 20ft container on the main deck and one additional container on the vessel, additional mobilization and demobilization time will be required. Likewise if custom instruments are to be integrated and cannot be integrated ahead of time, it may be necessary to extend the mobilization time.

### **Port Facilities and Equipment**

*Sentry* requires a crane capable of lifting 21,000lbs into position on the vessel. This varies from vessel to vessel, but a 100ton crane is sufficient for nearly all vessels including all UNOLS vessels.

*Sentry* also requires a 6000lb forklift and adequate dock space to bring in a truck, unload two containers onto the dock, and partially unpack them before loading them onto the vessel. Demob has the same requirements. It is critical to make sure that the dock can support the load of the truck and crane.

### **What We Will Need From You**

Typically you will not need to be concerned directly with arrangements for equipment and docks as either the vessel operator or WHOI will often make these arrangements, but for some projects these are made directly by the client, and it has a bearing on acceptable mob and demob ports.

Starting on the morning of the first day of the mobilization we will need the chief scientist or a representative generally available (even if only by phone) in order to make on the spot decisions about space and similar items.

## **Cruise and Survey Planning**

### **Joint Operations with Other vehicles and Assets**

*Sentry* regularly operates with other assets in the water at the same time including ROVs, CTDs, Towcam, and dredges. This is inherently an efficiency booster, but also a higher than normal risk operation which requires careful attention. The information below is a guideline, but all decisions of standoff distance and even if joint ops will be allowed are at the discretion of the Expedition Leader when on scene.

The most critical element during any joint operation is preventing collision between *Sentry* and the other asset or the cable. *Sentry* is not able to see or avoid something the size of a cable, and likely not a vehicle either. Secondary considerations include ensuring navigation for both vehicles, keeping an eye on *Sentry*, and being ready to recover *Sentry* at the proper time.

### **Navigation and Monitoring of *Sentry***

During nearly all cruises we rely on USBL navigation and acoustic communications. While the dead reckoning system on *Sentry* is typically capable of running the vehicle for an extended period of time without external aiding, the quality of the data, particularly for multibeam will be significantly better with regular external updates. This requires periodic co-location of the vehicle with the vessel within 2-3km in less than 3km of water, and gradually closer as the depth increases.

In addition to Navigation considerations, there is a vehicle risk issue. If we do not have any indication of whether *Sentry* is coming to the surface or not, it is possible for the vehicle to abort and arrive at the surface without us knowing. For this reason and to get a health message from the vehicle we prefer to either stay within range of the low frequency transponders (typically 6 – 8km slant range) or else check on the vehicle at least once every 6 hours.

### **Tracking and Air Traffic Control**

Any instrument in the water at the same time as *Sentry* must carry a USBL transponder. We typically have one or more spare units but can't always guarantee that, especially if the water will be deeper than 6km. Provided that we have reliable tracking for both assets, we are typically willing to operate with as little as 100m of vertical separation (cabled asset above *Sentry*) or 200 – 300m of horizontal separation with a quickly retractable instrument such as towcam or a CTD. For cores or dredges it would be more typical to prefer half a water depth or more. In all events the final decision about standoff distances will be up to the Expedition Leader

### **Dredges, CTDs, Towcam Etc**

These assets are characterized typically short dive durations relative to the length of an AUV dive. In these cases, we strongly prefer to bring these assets to the surface for all *Sentry* launch and recovery operations.

### **ROVs**

ROVs are similar to other cabled assets except that the dive duration is typically too long to allow *Sentry* launch and recovery to take place with the ROV in the water. Under some circumstances we are willing to launch and or recover *Sentry* with the ROV in the water. This is highly subject to the deck layout of the ship, the sea state, the vessel characteristics, etc. If you are planning on this, we suggest that you both contact us well in advance and have a backup plan in case sea state shuts down

such operations temporarily. We certainly don't want to discourage such operations as they are very effective and we routinely do this, but it is a more complex planning situation.

### Human Occupied Vehicles

To date we have not operated both an AUV and a human occupied vehicle (HOV) at the same time. The typical scenario is to alternate times in the water with the HOV diving during the day and *Sentry* at night. The limitation may be reconsidered in the future.

### **Weather Windows and Considerations**

The "weather call" is typically one of the more difficult decisions at sea. Moreover it is a decision that can really only be final when the people making it are standing together on the deck of the ship in the seas in question. That said, there are general principles that will be used to make the decision as well as some "typical limits"

### Principles for Weather Decisions

While at sea, the *Sentry* Expedition Leader, Captain, and Chief Scientist will all receive custom weather forecast twice a day. Based on this forecast and observed conditions, it will be necessary to make a dive/no dive decision prior to each dive and it may be necessary discuss early termination of the dive. This decision will be made collaboratively between the Expedition Leader, the Captain, and the Chief Scientist as well as anyone else that the three of them feel should be present such as a Bosun, or *Sentry* deck ops lead. After all discussion and input has been heard, the final veto power will still rest with the expedition leader and will not be questioned from shore or subject to override by any other WHOI staff on or off the vessel. Likewise the Captain has a concatenative veto in that he or she can independently determine that the weather is not acceptable without question from *Sentry* staff at sea or on shore.

When making the weather decision things that the Expedition Leader and others should consider are:

- Personnel safety is always paramount.
- Vehicle safety is only slightly less important than personnel safety.
- Plan ahead and assume things may be slightly worse than forecast.
- Recovery is much more difficult than launch.
- The vehicle can abort at any time. Never launch in something that you can't recover in
- The vehicle should not stay on the bottom through bad weather as an abort can occur at any time and weather may last longer than expected.
- It is not ok to leave the vehicle on the surface and wait for better weather to recover. Never let it get to the point where you feel this need.
- Once the weather is clearly declining, it may be suitable to dive in a slightly higher than normal sea state with the expectation that the seas will be lower by the time the vehicle is planned to surface; however, it must always be safe to recover the vehicle immediately.
- If acoustic comms have been rock solid and water depth is less than 4km it may be acceptable to dive with a plan for early termination. If that is the case it will be necessary to plan for adequate time to bring the vehicle back on board with a significant contingency. If conditions are changing rapidly or getting close to the edge, someone capable of making a weather call (someone Expedition Leader Qualified or a deck ops manager with long experience) should explicitly evaluate the conditions at a regular interval.
- You can always plan a shorter dive if the ability to abort early is in question.

- Sea state is typically more of an issue than wind, but the vehicle is a large sail hanging from the crane.
- Organized seas and long swells are easier than disorganized sea
- When wind, wave, and current are aligned things are easier
- Different vessels behave very differently in weather
- Play it safe. If you are agonizing over the decision, DON'T DIVE

### Typical Weather Limits

As stated multiple times, weather is very difficult to generalize especially across different vessels. The following are “typical maximums” and are meant to be a starting place. Many vessels will have more conservative limits while in some cases, a dive may continue in worse conditions. The final call will always rest with the Captain and Expedition Leader with either able to make a no decision without further question.

Typical indications for a no decision:

- Sustained winds in excess of 20 – 25 knts
- Gusts in excess of 25-30knts
- Seas more than 10 – 12 ft (considerably less on some vessels)
- Any combination of wind, wave, and current that makes precision maneuver of the vessel impractical
- Any combination of wind or seas that limit crane operations on that specific vessel.
- Any sea state regularly putting running water onto the main deck near the launch or recovery area.
- Any combination of wind, wave, and current which would limit ship movement with the USBL transducers in the water to less than the maximum commanded speed of the vehicle (typically 2knts)
- A prediction for any of these conditions prior to the scheduled recovery.
- Marginal weather and a significant uncertainty about future trends.

### **Survey Types**

There are a very wide variety of survey techniques that can be used, and we frequently invent new ones to solve new challenges. Discussions with *Sentry* personnel beginning at the proposal stage are recommended and it is important to give us a feel for your needs during the pre-cruise planning meeting so that we can work out any new techniques required.

Actual mission planning will take place at sea since factors such as current, weather, etc invariable change any plan once you are on site. While at sea, your Expedition Leader or Mission Planner will be well versed in survey options and can guide you in real time.

Notwithstanding the above, there are several common survey types which cover 80% or more of our users’ needs. These are discussed below.

### High Coverage Multibeam

At this time, the maximum swath with the Reson Multibeam is 180 - 200m in most terrain. This will generally occur at an altitude of 60 – 80m depending on terrain, bottom



composition, and any other goals for the dive and will have a forward speed of approximately 1.8knts (0.9m/s) for best data quality. 120kHz sidescan can be obtained simultaneously.

Coverage Rate  $\approx$  0.55 – 0.65 km<sup>2</sup>/h of bottom time

Typical Grid = 1-1.5 m

#### Maximum Resolution Multibeam

The maximum resolution multibeam achievable by *Sentry* is approximately a 0.3 – 0.5m grid and typically occurs from an altitude of 20m with a swath of 50 – 60m depending on terrain. Forward speed will typically be  $\sim$ 1.4knts (0.7m/s) though faster speeds are possible if the entire dive will consist of only this option, or if asymmetric grids (e.g. 0.3 x 0.5 for example) are acceptable. 120kHz sidescan can be obtained simultaneously.

Coverage Rate  $\approx$  0.12 – 0.15 km<sup>2</sup>/h

Typical Grid = 0.3 – 0.5 m

#### Wide Area Sidescan

The widest area sidescan coverage is obtained with the 120kHz system. The maximum effective swath is typically 600m unless you are in steep terrain. This does not provide sufficient overlap to fill the nadir. For best data quality, this should be run at a forward speed of 1.8knts (0.9m/s). Typical altitude is 30m, but this can be run between 30 and 70m reasonably effectively. 30m appears to provide the best data. The multibeam can be run simultaneously, but from 30m the swath of the multibeam will be approximately 90m.

Coverage Rate  $\approx$  1.9km<sup>2</sup>/h

#### High Res Sidescan with Photo Strips

A common technique is the simultaneous acquisition of 410kHz sidescan data with a photo strip down the nadir. Effective swath for this technique is approximately 150m in relatively flat terrain. Altitude is 5m and a speed of 1.8knts (0.9m/s) is recommended. The photos will have approximately a 5mx5m viewable area.

Coverage Rate  $\approx$  0.45km<sup>2</sup>/h

#### Dense photo coverage

Dense photo coverage implies approximately 30% overlap in the long track direction with a nominal 20 – 30% overlap across track. In practice, there are often small gaps between tracks especially in steep terrain or variable currents. Typical photos are 5mx5m and forward speed is 1.4knts (0.7m/s)

Coverage Rate  $\approx 10,000 \text{ m}^2/\text{h}$

### Sparse photo coverage

In this case the adjacent track lines become more spread out and overlap along track is reduced by increasing vehicle speed to 1.6knts (0.8m/s).

Coverage Rate (50% across track no overlap)  $\approx 25,000 \text{ m}^2/\text{h}$

Coverage Rate (10% across track, no overlap)  $\approx 130,000 \text{ m}^2/\text{h}$

## **Dive Times, Turn Around, Schedules, and Crew Rest**

### Dive Durations

Dive time is most frequently limited by battery capacity. Dives can generally be as short as desired (with some limitations on numerous very short dives) and can be terminated early on command.

When the battery is the determining factor in dive duration, several factors play a dramatic role including speed, sensors, and depth. For a full charge (see turn around section for exceptions), you should assume that you have 90% of the battery for use and then estimate dive times based on utilization of that battery. Typical values for both hourly usage and dive duration are given in Figure 7. Note that Ascent does not need to be included as it is part of the 10% not available to science. Other components of the 10% are contingency power and final pre-dive power. Typical on-bottom survey times in 2-3km of water are given in

Activity	Range of % battery use/hour	Typical on Bottom in 2km of water
Descent	2-3	N/A
Ascent	N/A	N/A
Multibeam w/ or w/o sidescan	5	16 - 18
Sidescan either type, no multibeam	4-5	18 - 22
Sparse photo coverage	3.5-4	20 - 24
Dense photo coverage	3-3.5	30 - 40 (not well known with new strobe and camera)

**Figure 7 - Typical Battery Usage Values**

When determining Ascent and Descent times, 40m/min is a conservative number and is the one we encourage scientists to use. Under certain payload conditions, we can achieve as much as 50% more than this, but you will need to contact us ahead of time to discuss if you want to plan for anything other than 40m/min.

### Turn Arounds

Turn around time is most typically limited by battery charging. Nominally a full turnaround is 16 hours, which is divided as shown in Figure 8. This is a conservative timeline, which means that under many circumstances it can be accelerated. This is a subject of discussion at any point, but most often the decision to accelerate it made collaboratively between the Expedition Leader and the Chief Scientist on the scene.

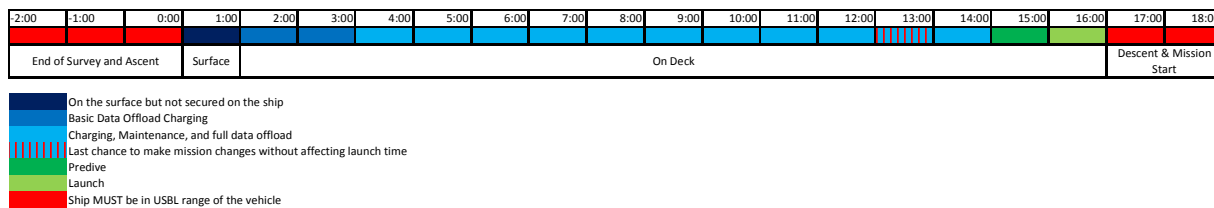

**Figure 8 - Conservative Breakdown of Standard Turn Around Time**

An accelerated turn around with a partial battery charge is also possible. This faster turnaround results in only 75 – 80% of the battery capacity useable to science but saves 5-6 hours in the turnaround at a typical cost of 2-4 hours of dive time. The space between these two options is a continuous spectrum. In practical point, the decision between these two turn around options will often be decided based on crew rest considerations as described below.

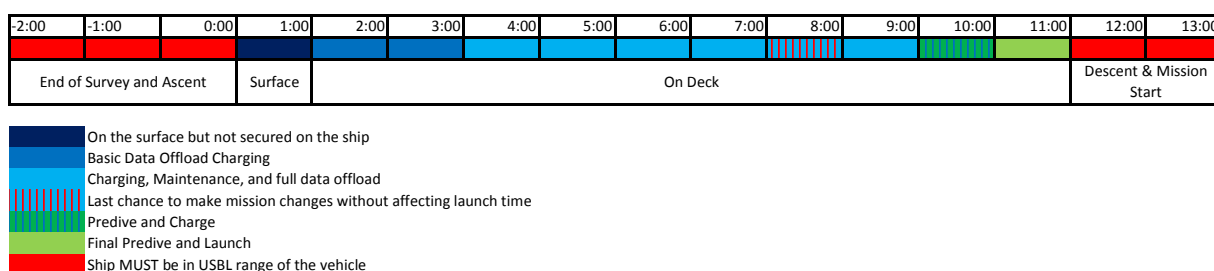

**Figure 9 - Accelerated Turn Around for Partial Battery Charge**

**Important Notes:**

- Depending on depth, the ship must be in USBL coverage (typically ½ - 1 water depth) two to three hours ahead of planned surface time. The exact timing will be up to the Expedition Leader, but the goal is always to have confirmed tracking at least 30 minutes before *Sentry* leaves the bottom. Depending on the uncertainty of the time of end of mission, weather, currents, vessel, and many other factors, this may be as much as 3 hours.
- It will be necessary to remain in USBL and acoustic modem range (typically less than ½ water depth) during most of the descent and bottom approach as well as the first 10 – 30 minutes of the mission. Exceptions to this are possible but will significantly degrade navigation and should be discussed before the cruise if not before the proposal.
- While we will make every attempt to accommodate late breaking circumstances and information, depending on staffing, any changes to the mission plan less than four hours before launch may delay the launch. Under certain circumstances this can be pushed as close as 45 minutes, but this requires planning at least a year in advance if you anticipate doing this on a regular basis as this imposes very specific needs on cruise staffing.
- This schedule assumes a full recharge of the batteries. This is not always necessary as described under crew rest below.

## Crew Rest

*Sentry* typically sails with a crew of five. A minimum of four people are required two hours before each launch to two hours after each recovery. For safety reasons as well as quality of life reasons (*Sentry* personnel typically spend > 100 days/year at sea), each person needs eight uninterrupted hours of sleep in every 24 hours and this must be at nearly the same time each 24 hours. Several common operations paradigms which meet this requirement are given below. We are open to other options as well, but if the sleep requirement cannot be met for two days in a row, or for more than a couple of times in the cruise, the Expedition Leader will halt or delay operations to whatever degree necessary regardless of other constraints or goals within the cruise. In cases where an absolute maximum schedule is desired, additional people have been added, but this is not a part of the facility and would need to be included in your proposal separately.

### Partial dives, 24 hour cycle:

In this scenario, *Sentry* will launch and recover at approximately the same time every day. In practice this typically will mean a 12 – 14 hour on bottom depending on water depth. This is especially common when operating with other assets such as *Alvin* or when operating from vessels with limitations on deck operations.

### Full dives, reduced speed, 48 hour cycle:

In this scenario, we reduce the forward speed of *Sentry* which improves power consumption and go to a 48 hour cycle where *Sentry* launches and recovers at the same time every 2 days. The lower power consumption leads to longer dives and hence makes up for some of the speed loss. This is effective with very little loss of coverage when doing dense photo surveys, and can be done with other types of surveys typically with a 10 – 20% loss of total coverage. This schedule has most often been used when other assets such as seismic systems are also deployed which can extend the desired *Sentry* turn around a bit as well.

### Blackout Window:

This is the most common schedule for *Sentry*. In this scenario, prior to the beginning of the cruise, the Chief scientist designates an 8 hour window during which *Sentry* will not launch and will recover only in an emergency. This window is the same time every day for the duration of the cruise. We will launch or recover on either side of this window (but not immediately on both sides in the same day) this means that the with the pre and post requirements of launch and recovery, staff are not required to shift their sleep period by more than two hours any given day. When combined with an accelerated turn around, this results in very little loss of total coverage since the dive can be moved up (and shortened) slightly or delayed (and lengthened) slightly to keep out of the blackout window.

## **Data and Data Handover**

The chief scientist of each cruise will receive 1 copy of all raw and processed data from the cruise. At a minimum this will include all of the data as described in Appendix A – Data. This copy may also include intermediate products, nascent products, mission planning files, and other elements which are described in a “Data Deliverables Summary” that you will receive with the drive.

### **Data Formatting**

Data formatting is a difficult issue given the variety of platforms. All of our data processing uses Ubuntu Linux and consequently we use EXT4 for most of our internal purposes. We strongly recommend that you do the same if you are able but recognize that other formats may be necessary. We can provide a freeware plug-in to allow easy access to EXT4 from a windows PC, but we have not yet found a viable way to enable this for Mac.

We are also able to write NTFS drives, but our experience is that you will see several corrupted files on a 3TB drive.

Prior to the start of the cruise we will ask you to confirm what data format you would like.

### **Additional Copies**

As a part of your cruise, the Chief Scientist will receive one copy of the data in the form of one or more external hard drives or raid arrays. We are happy to write additional copies, but you must provide the media in a format compatible with our systems. The exact media needs will vary by cruise, but typically will be either:

- 2 - 3TB SATA II or SATA III 3.5in internal hard drives (plus enclosures if you want them to be USB at the end) (Typically \$150 - \$200 each drive)
- 1 – ProRaid 4bay, USB 3.0 (UBB 2.0 or esata are not acceptable) with 4 - 3TB drives installed. Expect these to cost \$1200 - \$1500 each with drives.
- In extreme cases two or more of the pro-raid boxes may be required per cruise.

If you contact us ahead of time, we should be able to give you a good idea of what will be needed and can point you to specific links for purchasing the correct items online.

### **Archival**

All data from all *Sentry* cruises are returned to WHOI for archival in accordance with NDSF data management policy. For questions, please contact the NDSF data manager (Appendix D – Points of Contact and Resources). At the end of your cruise you will be asked to sign a receipt for your copy of the data. Included in the receipt is a question about data restrictions. NSF allows *Sentry* data to be restricted for up to 24 months at which point it will become publicly available.

## **Appendix A – Data**

### **Data Collected**

A wide variety of data is collected by *Sentry*. This includes scientific sensor data, command and control data and navigation data. Detail of each type of data collected is given below. It should be noted that data collected and data products delivered will always be modified in a logical manner according to sensors installed and the degree to which those sensors are able to collect useful data under the conditions in which they are used.

### **Scientific Sensor Data**

#### **Multibeam Echo Sounder Data**

*Sentry* carries a Reson AUV3 MultiBeam Echo Sounder (MBES). The primary data collected by the MBES is bathymetric swath data; however, backscatter, snippets, and decimated beam amplitude records are also commonly collected. When desired full phase and magnitude data can also be collected.

The AUV3 sonar records binary files in a proprietary Reson format called an s7k file. The file consists of a file header and footer with various “records” packed sequentially into the file. Each record contains a header and a footer as well as a specific type of data. A full description of records can be found in the Reson Data Record Definition available from Reson, but common records will include:

- Bathymetric soundings
- Backscatter data
- Snippet data
- Sonar settings
- Navigation records (empty – filled in post processing)
- “Compressed video” – decimated magnitude of time variant beam amplitude

An independent driver on the main vehicle control computer is used to configure and manage the MBES. This driver writes ASCII text logs including initialization file parameters, commands sent to the MBES, and state information received from the MBES.

#### **Interferometric Bathymetry, Sidescan Sonar, and Sub-Bottom Profiler**

*Sentry* carries an Edgetech 2200m integrated sidescan sonar/sub-bottom profiler. The 2200 can simultaneously collect two channels of sidescan data and sub-bottom profiles.

Data is recorded in binary files in an Edgetech proprietary format called a JSF file. JSF files do not contain file level headers or footers, but are a collection of individual records in the order they are written. A data record consists of a single ping from a single type of sensor.

#### **Digital Still Camera**

*Sentry* carries a color digital still camera. Data from each image is recorded in a Bayer encoded raw format. Post processing is necessary to convert this to an image suitable for normal viewing. Photo data products are discussed below.

## Eh Sensor

*Sentry* carries a Koichi Nakamura eh probe. The eh sensor reports probe voltages through an external A/D converter. These data are logged by a driver running on the main stack.

## CTD Data

*Sentry* carries a Seabird 49 CTD sensor. The CTD reports conductivity, temperature, depth, and several derived products such as sound speed in ASCII format via RS-232. These data are logged by a driver running on the main stack.

## Magnetometer

*Sentry* carries an APS1530 three-axis flux gate magnetometer. The magnetometer reports raw magnetic field values in three dimensions via RS-232 in either ASCII or binary format. These data are logged by a driver running on the main stack.

## Optical Backscatter

*Sentry* carries a Seapoint optical backscatter based turbidity sensor. The Seapoint reports turbidity measurements via an external A/D converter. These data are logged by a driver running on the main stack.

## Dissolved Oxygen

*Sentry* carries an Aandaraa Optode dissolved oxygen sensor. The Optode reports Oxygen concentrations via RS-232 in ASCII format. These data are logged by a driver running on the main stack.

## Sensors of Opportunity

Several Ethernet and RS-232 ports are available for integration of sensors of opportunity. Each of these sensors will require a custom software driver, several cables, and other similar prep work so it is important to engage us early.

## Command and Control Data

Numerous log files are generated by the vehicle control software. It is hoped that future versions of this document will elaborate on this, but it is very rare that these raw logs will be needed by scientists. In the event that they are required, contacting us directly is presently the recommended course of action.

## Navigation Data

There are five primary sources of navigation data including the sensor drivers for the INS and DVL. Two of these sources, the subsea navigation estimator and the raw USBL data are unlikely to be utilized in the post processing pipeline.

## Doppler Velocity Log Data

The DVL along with the gyro angles from the PHINS form the basis of the dead reckoning navigation. The log files created by the DVL driver are primarily for archive as the data from the subsea navigation estimator is primarily used for the renavigation process.

## Inertial Navigation and Gyro Data

The PHINS INS system provides both inertial navigation data and gyro angles. At present only the gyro angles are used. The logs created by the PHINS sensor driver are parsed and fed into the renavigation process (see below).

### Topside USBL Data

The Sonardyne system generates raw log files associated with USBL tracking. Generally these logs are recorded and retained, but are not actually used.

### Topside Navigation Estimation Program Data and Logs

The topside navigation estimation program creates log files which include USBL fixes, ship position, ship heading, and other similar data. These log files are the source of data for the topside navigation post processing and renavigation process as described below.

### Subsea Navigation Estimation Program Data and Logs

The subsea navigation estimation program is substantially similar to the topside navigation estimation program. The real time dead reckoning estimate in particular is contained in these logs. These logs are also the source of key pieces of sensor data including the INS, and DVL. The dead reckoning is fully reprocessed during the renavigation process to allow for corrections such as sound velocity.

### Post Processing

The information in this section is more detailed than most users may want. Unless you have specific interest, we recommend skipping to the “Data Products” section below.

During any dive, substantial data is collected. Specific raw data types are described above, but generally the raw data are not in a format that is useful to most scientists. Post processing is generally necessary to develop derived data products. The general flow of data post processing is shown in Figure 10.

The first step is always to move the data to a backed up archive. The next step is to convert relevant data from the raw log format (e.g. ASCII) to Matlab structures which are compatible with the remainder of the pipeline. Once the data has been suitably ingested into Matlab the next step is to create a best estimate of the vehicle position. The output of the initial parsing and navigation processes are several data files which then are combined with raw data products from other sensors to create final derived data products such as maps and annotated images. Each of these processes is described in additional detail below.



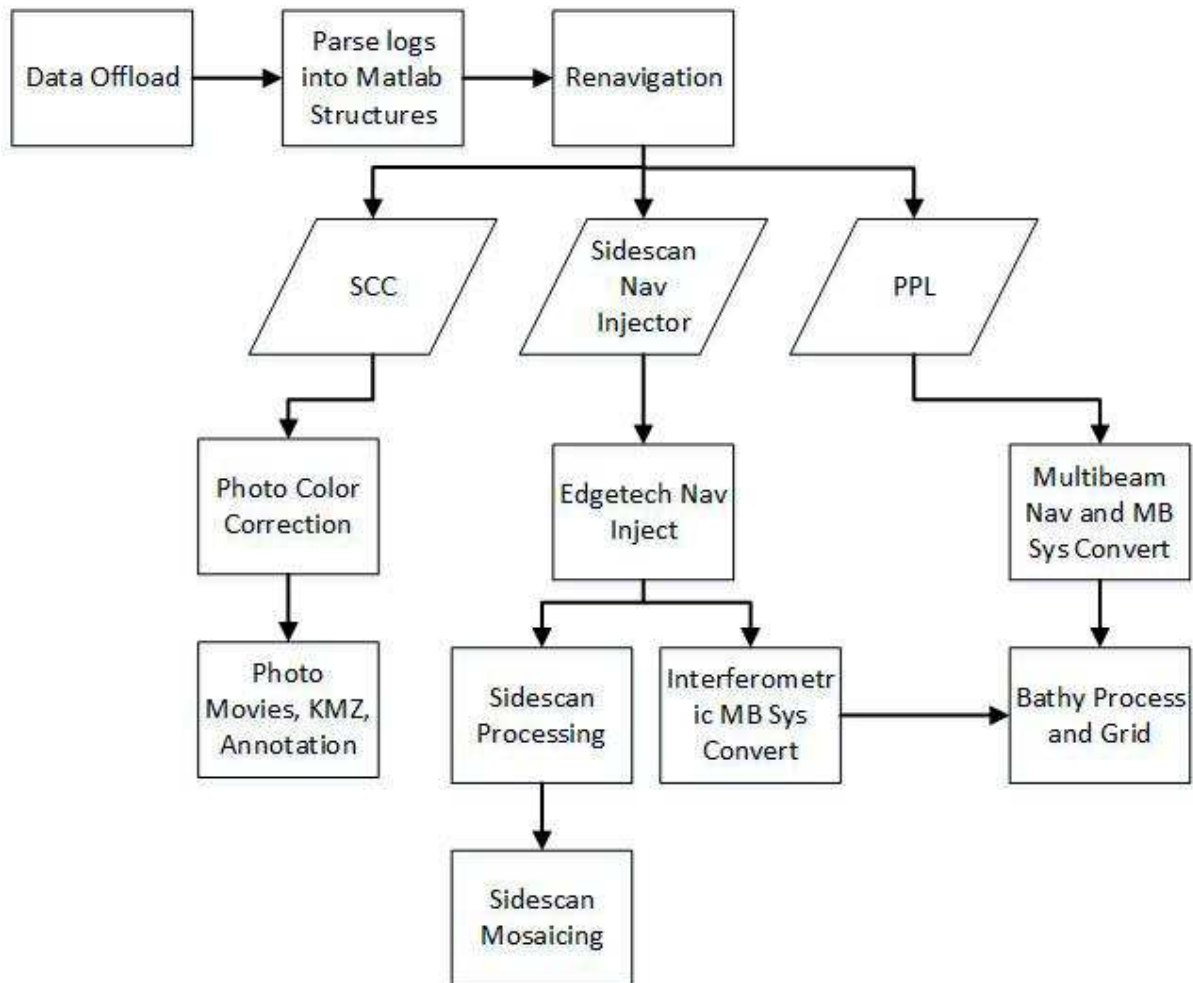

Figure 10 - General Post Processing Work Flow

### Initial Data Ingestion

For *Sentry* most data is recorded in ASCII text logs at the rate of one file per hour. These data will need to be extracted from the logs and put into a more readily analyzable format. Selected data is pulled from these logs into Matlab structures where previously developed tools can perform appropriate operations. Typically several engineering structures are created as well as a structure for any sensors which do not require further processing later.

For *Sentry* the sensors with structures include:

- Sound Velocity Probe
- CTD
- Magnetometers
- Optical Backscatter
- Eh
- Dissolved Oxygen
- DVL
- INS
- Depth
- Topside Navigation data from Navest

- Structures are commonly created for other custom sensors as well

In addition at least the following engineering data will be parsed into structures for diagnostic and other purposes:

- Thruster commands and reported values
- Mission Executive State Changes
- Bottom follower parameters, goals, references, and reported values
- Battery status/power usage/etc as available
- Safety sensor outputs such as leak detects, humidity and temperature sensors and ground fault detectors

Data which is not ingested into Matlab includes:

- Multibeam data
- Sidescan data
- Interferometric data
- Photos
- Sub Bottom Profiler data

### Navigation Processing (Renavigation)

The most important data-set for any AUV operation is accurate seafloor navigation. The navigation used for *Sentry* is typically an ultra-short baseline (USBL) system augmented with an inertial navigation system (INS) and Doppler velocity log sonar (DVL).

At the end of each dive, the data from the USBL, INS and DVL are processed to remove outliers, correct for sound speed, and other similar corrections, and then are combined using WHOI developed code to form a final post processed navigation estimate. The final processed navigation data is reported in Latitude and Longitude in decimal degrees (suitable for importing into GMT and other mapping tools) and is embedded within the time-stamped scientific data file for each dive (see later).

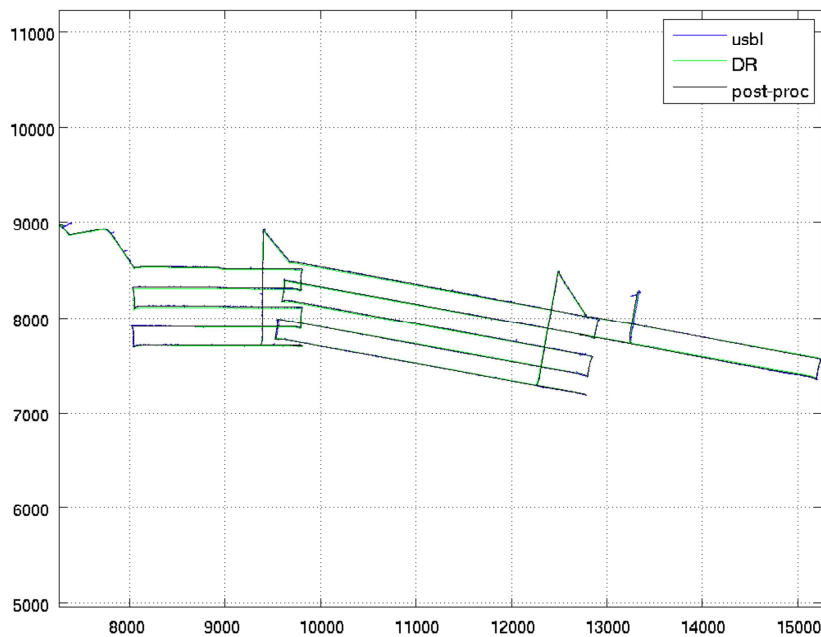

Figure 11 - Example of processed post-dive navigation data (black line) as derived from within-dive USBL fixes (blue line) from a *Sentry* multibeam run (80 meters height) (D.Yoerger, WHOI). The post-dive corrections are quite small, the rms value of the combined x and y correction for the entire dive is less than 10 m (Fig.2)

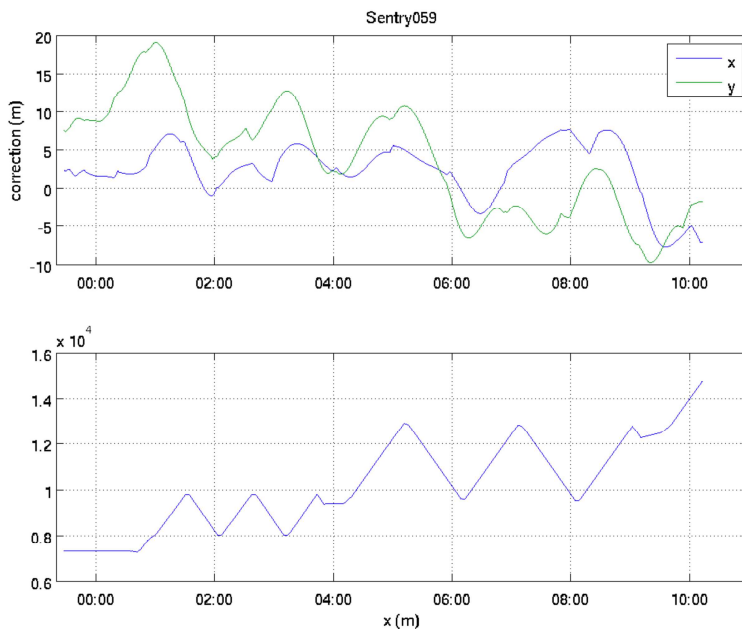

Figure 12 - This plot shows the post-dive correction applied to the real-time dead-reckoning track (upper panel) and the x coordinate of the processed track (lower panel). We conclude that our real-time track, which does not use USBL or LBL information, remains consistent with the USBL track to within 10-15 meters.

The tool used to post process the navigation is referred to as renavigation and was developed at WHOI and is part of the DSLPP Matlab library. When the renavigation pipeline is run, a default script with standard parameters suitable for most situations is copied from a revision controlled repository to the nav-sci/proc directory for the dive. Parameters can then be edited if required without affecting the global default. The renavigation process requires only minimal intervention by the user in most cases with the most critical decision being the correct cutoff frequency for the complimentary filter used in the algorithm. Methods for selecting the cutoff frequency and modifying other similar parameters will be provided in the data post processing manual.

### Chemical, Geophysical and Physical Oceanography Data

For the purposes of this document, Chemical, Geophysical and Physical Oceanographic Data will include:

- CTD
- Sound Velocity
- Dissolved Oxygen
- Eh
- Optical Backscatter
- Magnetometer

The data from the Chemical, Geophysical and Physical Oceanographic sensors is parsed into Matlab structures as a part of the initial data ingestion process described above. It is then combined with the renavigation data and navigated matlab structures are created and saved. The data is also written into the SCC file which is a comma separated ASCII text file which includes navigation and sensor data including these sensors interpolated onto a one second time base.

### Bathymetric Data

Multibeam Echo Sounder (MBES) data is processed using a somewhat customized version of MB System, an open source package for multibeam data processing. In addition to certain customizations, WHOI has developed several tools to speed the process and created a wrapper which takes care of integrating vehicle data such as dive times. In general the process is:

1. Raw Reson data files are run through a WHOI created program called s7kextract. This removes data not relevant to bathymetry and significantly speeds processing
2. The extracted records are run through mb7kpreprocess where they are combined with the PPL file created during the renavigation process and imported in an MB System format.
3. The data are run through a program called MB Clean which removes most fliers and artifacts from each sonar ping. WHOI has a custom version of MB Clean which is generally successful at filtering data sufficiently to make publication quality maps without the need for hand editing. This is not always the case, particularly in very steep or unusual terrain.
4. The data are combined with a tide file generated by a University of Oregon tide model as well as several vehicle parameters such as lever arms between the INS and MBES using a program called MB Set
5. The data are translated into world space and with all previously applied corrections by a program called MB Process.
6. GMT grid files are created using a process called MB Grid
7. Various WHOI and MB System scripts are used to create the specified data products such as PDFs

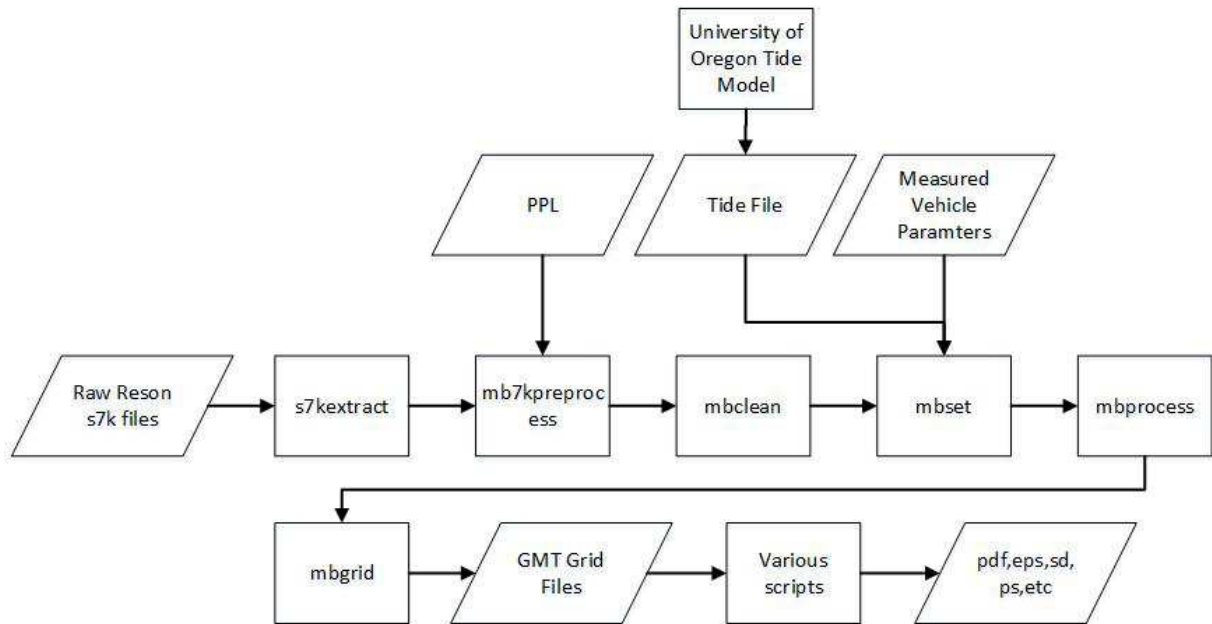

Figure 13 - Reson Multibeam Post Processing Work Flow

#### Water Column Multibeam:

With help from the folks at the NOAA OER program, we have learned to ingest the water column data from the *Sentry* multibeam into Fledermaus in order to display bubble plumes in the context of other data. This is a nascent capability and is not supported as standard.

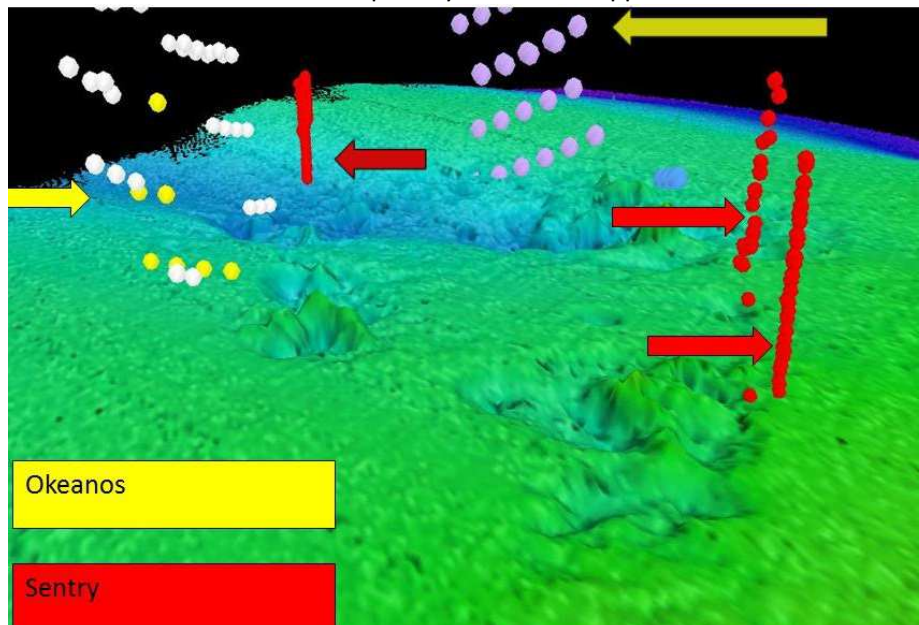

Figure 14 - Bubble plumes from both the Okeanos Explorer Hull mounted multibeam (yellow, white, purple) and from the *Sentry* multibeam (red). Image generated by Elizabeth Loebecker with data from Cindy VanDover.

## Photographs

Still photographs are collected as raw Bayer Images. WHOI uses a proprietary process based on Open CV to color correct and light balance these images. Next an unsharp mask is applied and TIFF images are created. An additional WHOI proprietary process referred to as Moviemaker then ingests the SCC file created during the renavigation process and creates the various data products described below including the annotated images, the movies, and the KMZs.

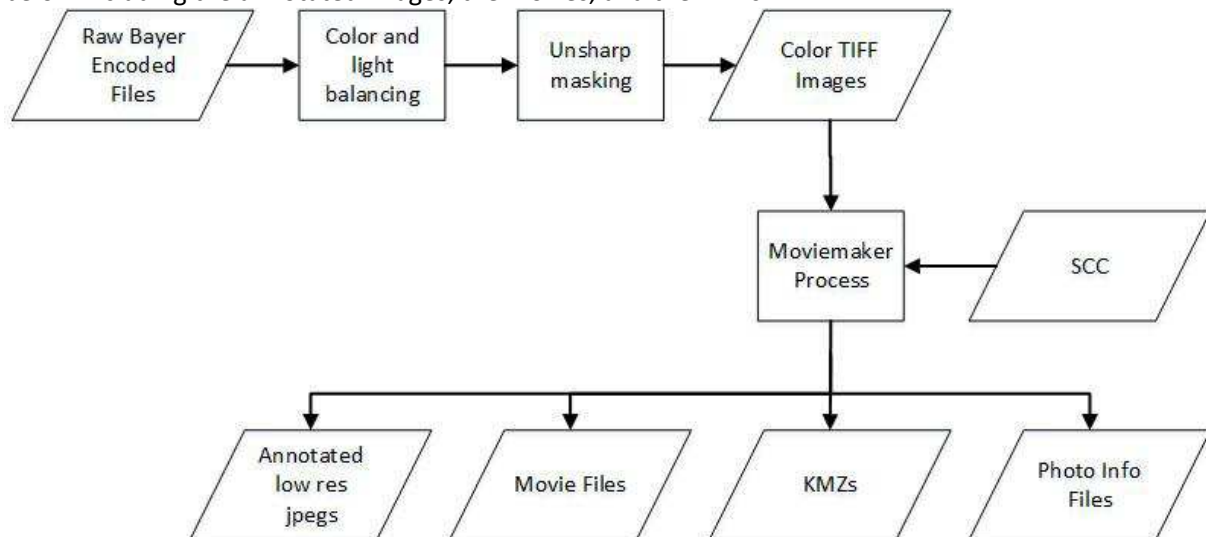

Figure 15 - Still photo post processing pipeline

## Chemical and Physical Oceanography Data

Chemical, Geophysical, and Physical Oceanography data are fully post process including generation of the SCC file by the initial data parsing and by the renavigation process. No further steps are required.

## Sidescan and Sub-bottom

The data pipeline for sidescan and sub bottom data is summarized in Figure 16. Sidescan and sub bottom data are both contained in the same raw JSF files. The Nav Injector file generated by the renavigation process is combined with the raw jsf files to create a new set of navigated jsf files. The navigated jsf files are imported into Sonarwiz. At this point the pipelines diverge.

The sidescan pipeline must first be bottom tracked and then gain corrected. The navigated and gain corrected sidescan is used to create annotated waterfall plots and geotiffs of the individual strips. This same data can also be used to create a gain matched mosaic if desired.

The sub bottom data is gain corrected. From the gain corrected data, annotated strip plots are created. Sonarwiz can also create strip plots suitable for import into Fledermaus.

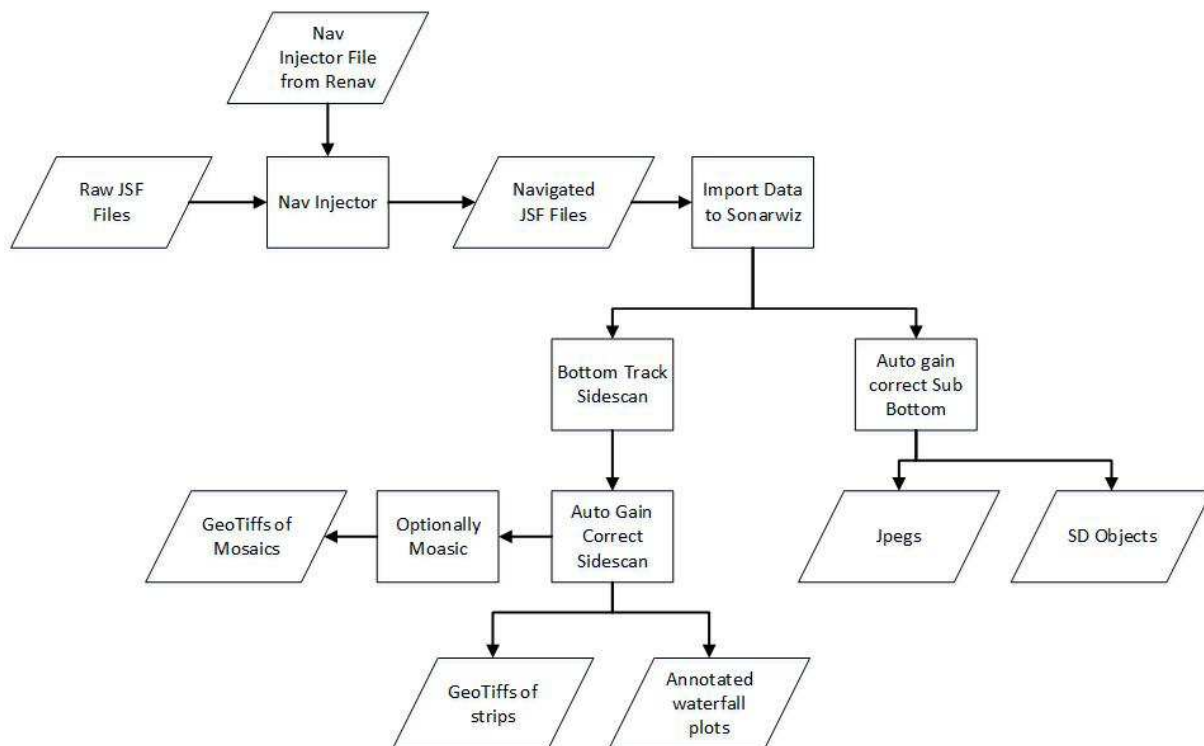

Figure 16 - Sidescan and Sub Bottom post processing flowchart

### Data Products

Precise navigation, robust control, and co-registered sensors permit *Sentry* to characterize the seafloor and the near-bottom environment on the meter-scale (absolute) to decimeter-scale (relative) through complementary sensing modes. There are several different data types, hence, data products that can be collected routinely by *Sentry*. Two tables at the end of this document list a complete set of these data types – both those that represent the standard data sets provided for all *Sentry* NDSF cruises (Table 1) and those that are under development (sensors acquired since *Sentry* entered the NDSF) but are not yet sufficiently robust to be considered standard deliverables (Table 2).

Category	file type	suffix	contents	usage
Nav./ Sensors	summary file (flat ASCII)	.scc	date, time, lat, lon, depth, height, conductivity, temperature, magnetometer	import to other packages for analysis, plotting
Bathy	gridded bathy	.grd	gridded bathymetry	import to other packages such as matlab or GMT for generating plots or analysis
Bathy	gridded bathy	.asc	arc/info ASCII grid	import to GIS
Bathy	gridded bathy	.ps, .pdf, .png	bathy image	import into documents (MS Word), latex), web pages

Bathy	fbt	.fbt	edited and geolocated multibeam ping data	import to packages to grid and display data such as Fledermaus, Matlab.
Photos	raw image file	.tif	raw image directly from camera	image appears monochrome, must be bayer-encoded for color. Not useful without further processing
Photos	raw color image file	.tif	bayer encoded image processed by real-time software	color image, before equalization or color balancing. Not useful without further processing.
Photos	processed color image file	.tif	color-balanced and equalized images	import into documents, web pages, or mosaic packages
Photos	photo movie	.ogv, .mp4	color balance and annotated images stitched together into a movie file	rapid review of large numbers of photos
Photos	kmz files	.kmz	color corrected, annotated, and geo-referenced photos	Importing photos into google earth
Sensors	mat files	.mat	sensor data recorded at native rates	import into matlab for processing. This is the preferred route for data such as magnets where downsampling and time interpolation of the .scc file is inappropriate.
CHIRP & Sidescan	navigated sub bottom & sidescan files	.jsf	Edgetech sub bottom and sidescan files	Useful if adding new navigation tracks
CHIRP & Sidescan	navigated sub bottom and sidescan files	.jsf	Edgetech and sub-bottom files with the navigation headers populated	Can be pulled into MB systems or other similar software for further processing.
Sidescan	Geo TIFF	.tif	Geolocated strips of gain corrected, bottom tracked sidescan data	Can be exported into GIS, fledermause, etc
Sidescan	Chesapeake project files	Multiple	Project files from sidescan processing	Further processing of data using Chesapeake software
CHIRP	JPEG strips	.jpg	Annotated gain corrected pictures of tracks	Visualization of sea floor layers

### Delimited ASCII Navigation and Sensor File (SCC)

In addition to bathymetry and photographic data, numerous other sensors are employed on *Sentry*. These data are compiled at the end of each dive into a single scientific data file that is made available as a comma-separated-variable text file. This is a format that can readily be imported into numerous data-analysis programs such as MatLab or other software appropriate for handling large data-files.



The science data in each .scc file is organized into columns with headings that cover time, processed navigation (vehicle position given in latitude and longitude in decimal degrees), depth, pressure (the primary variable from which depth is derived), height off bottom and heading (both essential for photo-mosaicing). Oceanographic data included in the same file include conductivity and temperature from each of the two CT pairs mounted on the vehicle and optical backscatter output from the Seapoint OBS instrument. Geophysical data collected routinely on all deployments (in addition to the bathymetric data discussed previously) includes 3 components of magnetic field data from the magnetometer.

### Navigation and Sensor Plots

**Figure 17 - Example of sensor data laid over the top of a re-navigated path. This data was collected on a Sentry dive during a Cindy VanDover cruise.**

A wide variety of plots showing sensor data combined with navigation are created. Figure 17 shows an example of one of these plots using data generated by *Sentry*

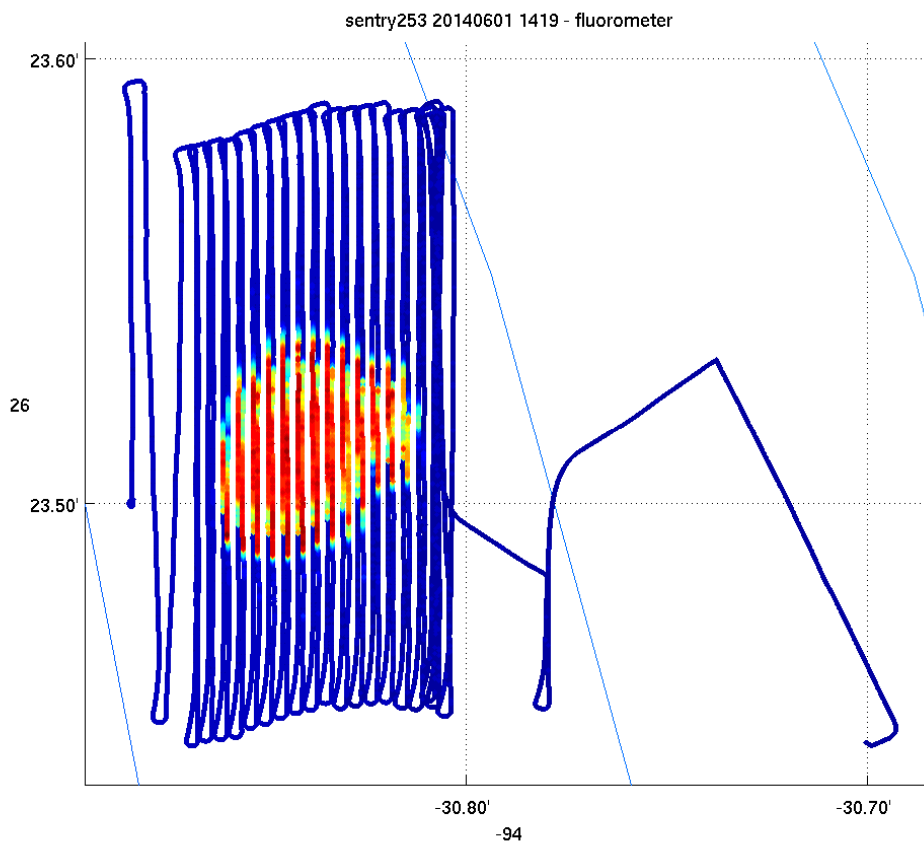

In addition to navigated plots, time series plots of some data are also generated. Figure 18 shows an example of such a plot which was generated using *Sentry* data.

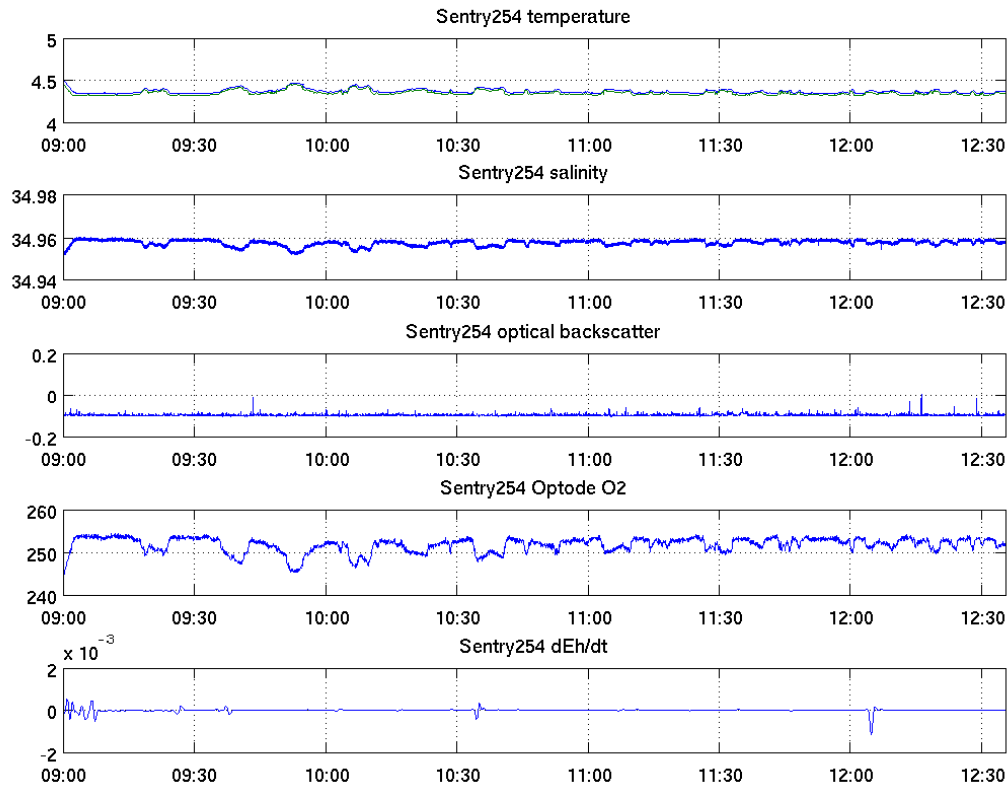

Figure 18 - Example of time series plots of Sensor data generated during a *Sentry* dive on a Cindy VanDover cruise

### Navigated Matlab Binary Files

The raw logs from the C&C systems and most instruments are ingested into Matlab for data post-processing. These logs are ingested into structures which incorporate time, sensor data, and derived products related to the sensor. These structures are saved as binary Matlab files (.mat.) Once the renavigation process is complete, a second copy of these files is created which incorporates the navigation data into the structure. These files can be easily read back into Matlab or Python for further data analysis by scientists.

### Bathymetric Maps

The bathymetric data generated by *Sentry* are made available to the science user in four data product forms suitable for different science user needs:

- raw and processed navigated profile data files (mb88 format for the Reson or mb<xxx> format for the interferometric system). These can be re-processed by the science party as required. The science party may decide to hand-edit the data to recover those few good soundings that our automated editors have removed and to

remove the few remaining fliers. We believe recent improvements in our automated editor make this unnecessary (Fig.3), but if detailed map interpretation is critical we recommend a careful review of the edited profiles by someone with good geological insight.

- gridded (at appropriate resolution) data files in .grd format which can readily be imported by the scientist into generic software such as *GMT*, *Fledermaus* or Matlab, whether at sea or for post-cruise analysis.
- fbt files: this is an mb-system format for the navigated, edited ping data that can be readily loaded into Matlab or Fledermaus. These files can also be used to produce additional grids (different grid spacing) or to produce grids from multiple dives.
- processed map *images* in .eps, .ps, and .pdf formats that can be used by the science party for immediate visualization of the gridded data set, further dive planning while at sea and post-cruise report generation and publications.

It should be noted that in general, NDSF is only able to deliver bathymetric data products that are the result of our automated process. Skilled data processors can typically remove additional artifacts and generally improve the map. If at sea staff have the time and skill, they may choose to do this, but it will be at the discretion of the expedition leader and not all data processing staff have this capability.

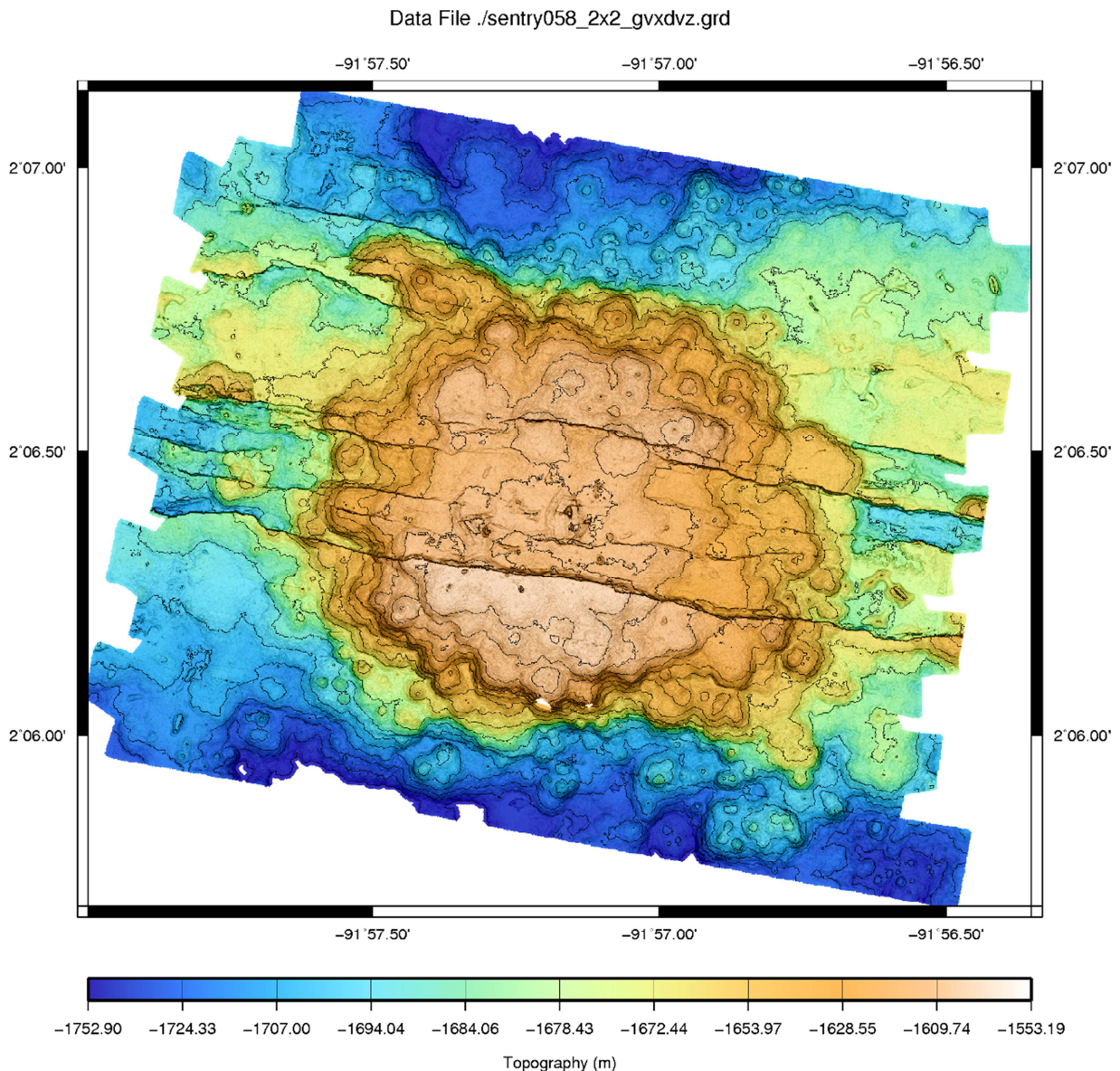

**Figure 19** Example of a bathymetric map image generated at sea (J Sinton, University of Hawaii, D.Yoerger, WHOI). This image was produced using only our automated scripts with no hand-editing or final navigation correction.

### Sidescan Waterfall Plots

Sentry is equipped with a sidescan sonar system at 120kHz, 410kHz, or both. Raw sidescan data is delivered as navigated JSF files. In addition to raw data, gain corrected, bottom tracked, and nadir trimmed strip plots for every survey line are delivered as geoTIFF files. Non-publication quality (i.e. non gain-matched) mosaics are generated as part of the standard strip plot data pipeline however these are in a SonarWiz proprietary data format. They can be exported upon specific request. Hi quality gain matched (i.e. publication quality) mosaics and mosaics draped onto bathy in a Fledermaus scene can be generated with the same software, but the at sea data



processing load involved in this is substantial and has only occasionally been supported by a standard five person *Sentry* team.

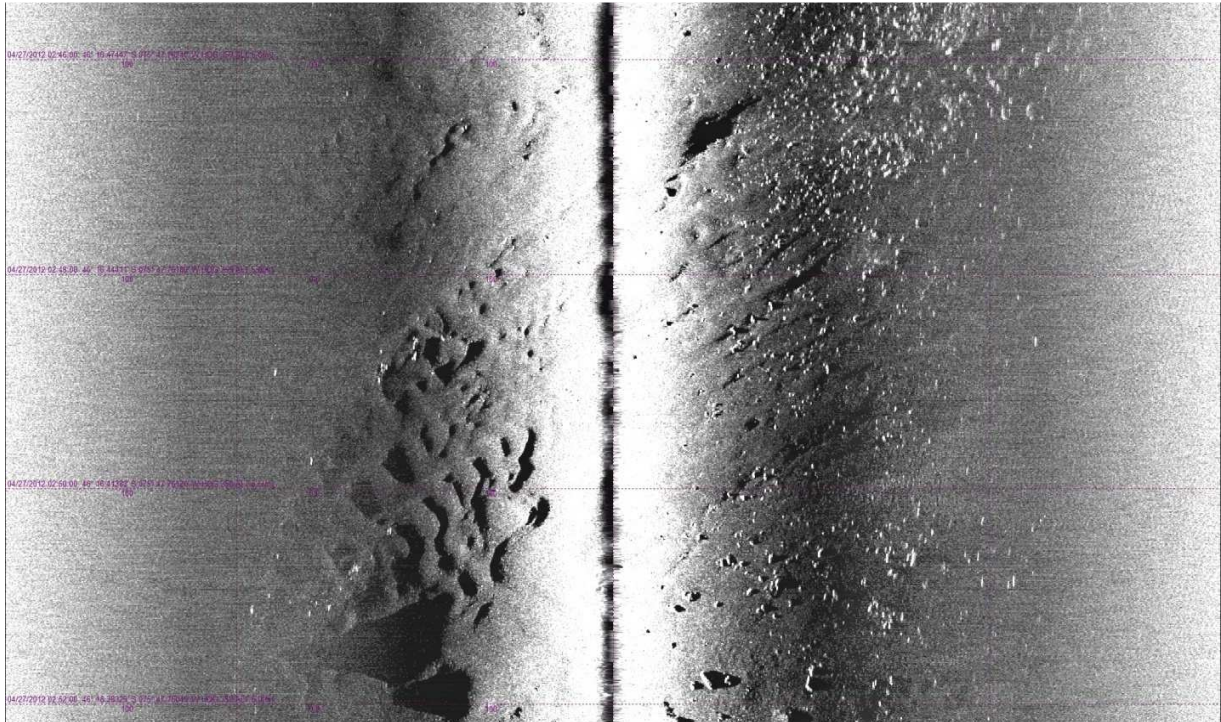

**Figure 20 - Image from a steep side hill with the sidescan. This is a typical format for the standard data product (Image from Donna Blackman)**

### Sub Bottom Strip Charts

*Sentry* carries an Edgetech 2200m system which includes a subbottom profiler (SBP). The SBP which uses a CHIRP signal (a broadband, swept waveform) in the 4-24 kHz range. This device is suitable for estimating sediment cover in volcanic terrain, and can penetrate softer seafloors to a depth of several 10s of meters. We have also used this sonar to detect probable methane seeps.

Data from the subbottom profiler is recorded in Edgetech's proprietary .jsf format with navigation records left blank. The .jsf files are copied and the navigation records are populated in the copy based on the post-processed navigation estimate. This task is carried out using a program called Nav-Injector Pro which is a part of the Sonarwiz package by Chesapeake.

Navigated .jsf files are imported into Sonarwiz and annotated strip plots are generated in TIFF format. An example output is given in Figure 21. SD objects suitable for import into Fledermaus can be generated.

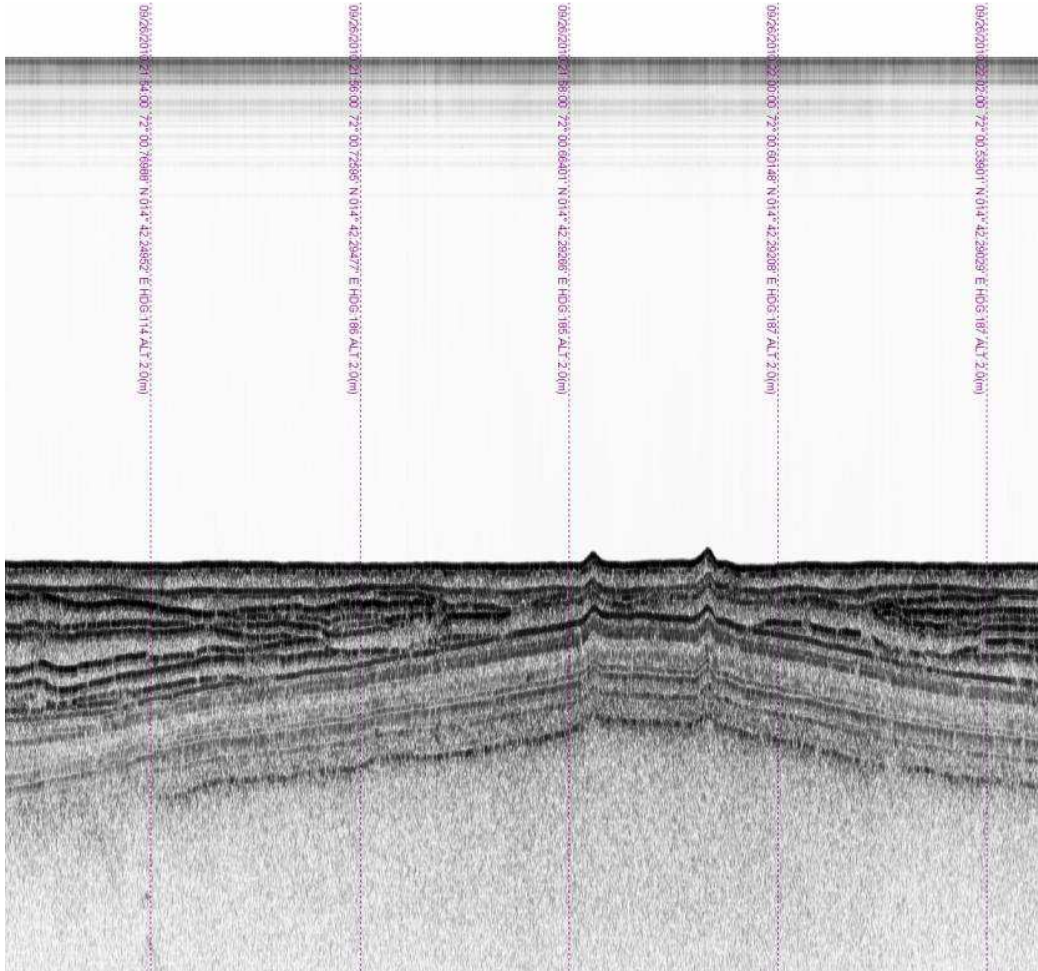
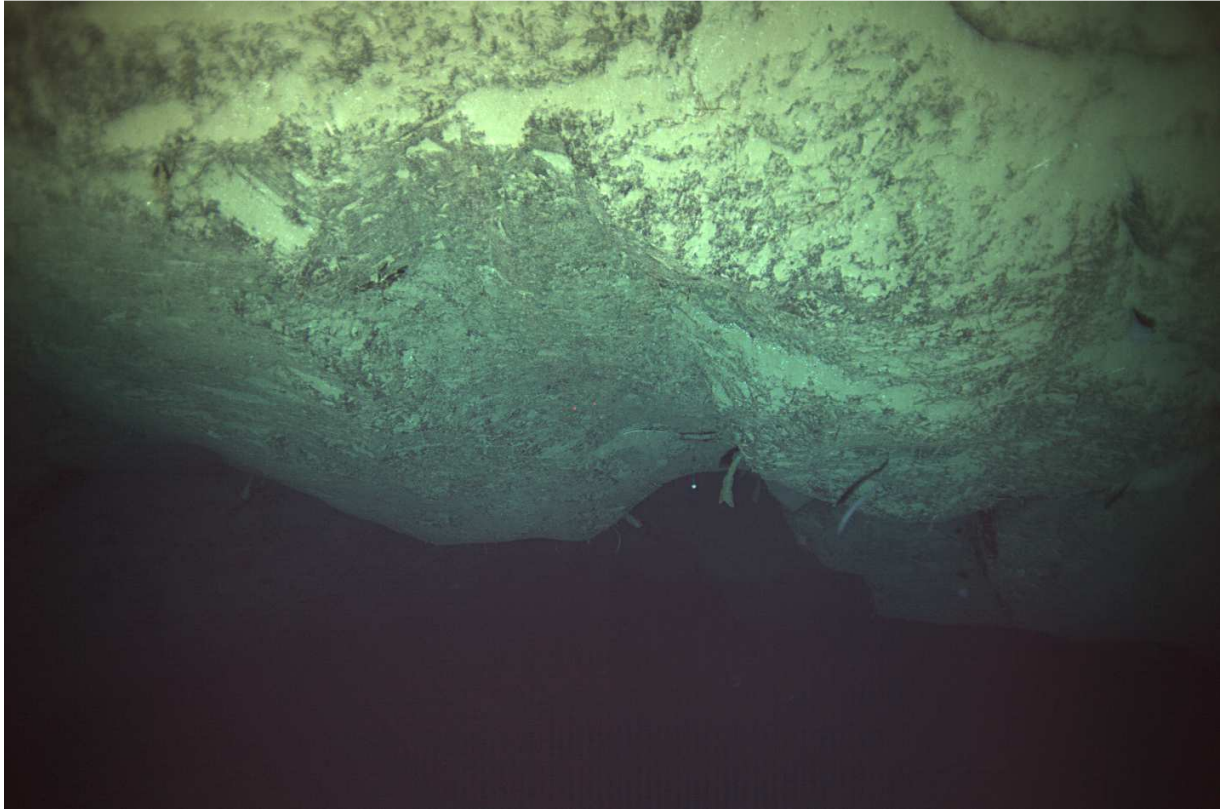

Figure 21 - Typical Data Product from a the Sub Bottom Profiler (Image from Chris German)

### Photographic Products

The standard photographic data product is a set of processed, time-stamped, color TIFF files. Photos are color corrected and sharpened via an automated script.



**Figure 22 - Example of a recent *Sentry* photograph (from a Cindy VanDover cruise)**

In addition to the basic photos, .ogv and .mp4 movie files will be generated that contain annotated images in succession for rapid review. Images are also provided in .kmz format for automatic import into Google Earth and in annotated low resolution jpeg files for easy transport and review.

### **Custom Data**

Many science users wish to receive data either in custom formats or to use their own sensors. We do our best to accommodate these requests whenever possible. To maximize the chances for success, we strongly recommend discussing these topics very early in the pre-cruise planning process (six months before departure if possible) or possibly even prior to proposal submission if it is critical to the cruise.

### **Nascent Data Products**

At any given time we have a number of nascent data products which are under development or which we know how to make but are too time intensive to regular delivery. A handful of these are discussed below. If these are of interest, talk with us as early as possible. In some cases, we can do them for you for a few dives, or on a time available basis, or teach a student, or through a separate post processing agreement, or a wide variety of other options. The earlier you engage us in these conversations the better the chance we can accommodate your needs.



### Water Column Multibeam:

With help from the folks at the NOAA OER program, we have learned to ingest the water column data from the *Sentry* multibeam into Fledermaus in order to display bubble plumes in the context of other data.

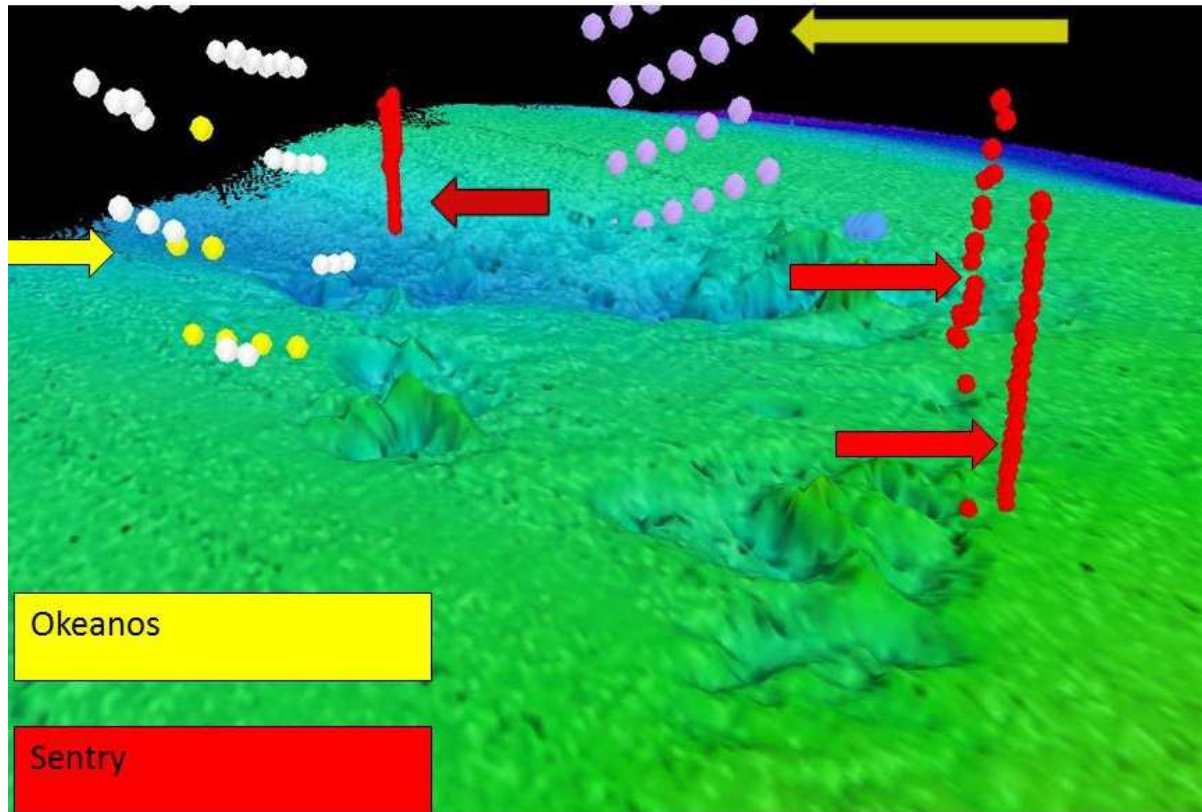

Figure 23 - Bubble plumes from both the Okeanos Explorer Hull mounted multibeam (yellow, white, purple) and from the *Sentry* multibeam (red). Image generated by Elizabeth Loebecker with data from Cindy VanDover.

### Sidescan Mosaics

The standard data product for the sidescan system is a swath strip. It is possible to put these swaths together into mosaics. We have only a single license for this software and doing a good job is time intensive. We can typically create a very rough mosaic Figure 24 for you, but a publication quality mosaic Figure 25 is very time consuming and we are often unable to do this without additional staff.





**Figure 24 - Example of a rough sidescan mosaic. These are typically easy to make but do not deal elegantly with overlap, nadir, etc. Data from Cindy Van Dover and Laura Brothers**



**Figure 25 - Detailed sidescan mosaic. These are time consuming to make and require substantial expertise from the data processor. Data from Craig Moyer and Brian Glazer.**

### Fledermause Visualizations

We have learned to put many of our data products and other non-standard types of data into Fledermaus Scenes. This is fairly labor intensive and often not something we are able to do for the full cruise, but it is a compelling way to look at the data. We carry a very limited number of Fledermaus dongles and can't necessarily provide one for the whole cruise, but this is an example of something we may be able to do for one site, or teach a student to do if you have a student, dongle, and computer.

### Blueview Imaging Sonar

Sentry has acquired a Blueview P-900 imaging multibeam. This sonar is mounted forward looking and to date we have used it primarily for obstacle avoidance. We have experimented with pipelines for seafloor mosaicking and vertical face multibeam maps. Both of these pipelines remain highly developmental.

### **Timeliness of Data Delivery**

Oceanographic sensor (e.g., CTD, OBS) data, co registered with navigational data, are typically available to the science party within 3 hours of the end of the dive. The larger volumes of multi-beam, sub-bottom, sidescan, and/or photographic data collected by contrast, typically require longer download times and substantially more processing effort. Preliminary multi-beam maps are usually available within 6 hours. Camera imagery post-processing is automated but (depending on the number of images obtained) requires 12 to 24 hours before the final pictures can be delivered to the science party. Sidescan strip plots can typically be delivered in 24-36 hours (mosaics and drapes if agreed to, may take days to weeks as they have to be fit in around other workload.) due to the long download times and the substantial effort associated with gain correction etc. Sub-bottom data can typically be delivered within 3-6 hours of recovery but since the data is in the same file as the sidescan data, it can take significantly longer to download and deliver if the sidescan is installed.

At the end of the cruise, we provide the Chief Scientist with one complete copy of all of the data collected on external USB hard drives (formatted as EXT3 or NTFS). If a ship data server is available, data files such as the SCC files and the multibeam sonar GRD and postscript files may be uploaded to the server as they are completed. A *Sentry* data server may also be set up to provide access to files for the broader science party. Similarly, the Science Party is free to bring additional drives, as required, for additional copies to be made. Please see drive recommendations under Data and Data Handover as storage needs may surprise you. These should be free of all other content, and should be provided to the *Sentry* team at the outset of the cruise to ensure that the entire data-set can be transferred to the drive in a timely fashion.

In addition to the standard data products listed here, the *Sentry* team also generates a summary report at cruise ends that details all *Sentry* operations and lists all data products generated during the cruise.

### **Organization of Delivered Data**

Data Organization is not discussed in detail here. It is presented in "Appendix I – Organization of Delivered Data" so that is more of a standalone section for portability.

## **Appendix B – Sensor Details**

### **Sidescan Sonar and Sub Bottom Profiler**

*Sentry* uses an Edgetech 2200M combined dual-frequency sidescan (SSS) and subbottom (SBP) survey system. When this system is active *Sentry* will continuously record data in raw JSF format, which is an Edgetech proprietary format. The *Sentry* JSF files contain both SBP and SSS data with time-stamped headers, but WITHOUT navigation data. Navigation data is injected into the JSF files during post-processing after the AUV navigation has been processed and cleaned.

The dual frequency 120 & 410 kHz sidescan sonar uses Chirp technology and simultaneously transmits linearly swept frequency modulation (FM) pulses centered at two discrete frequencies. These long duration pulses are calibrated with wide band signals to reduce the acoustic side lobes and improve the signal-to-noise (SNR) ratio, thereby improving the detection range of the sonar.

The DW-424 subbottom profiler system also uses Chirp technology and transmits a single digital linear FM pulse to produce acoustic transmissions in an up-Chirp or down-Chirp pattern; sometime referred to as a frequency sweep. A linear FM up-Chirp, moving from lower to higher frequencies, is typical in subbottom Chirp systems. In contrast, one could create an exponential sweep to produce a large frequency range in the same amount of time (or over the same pulse length).

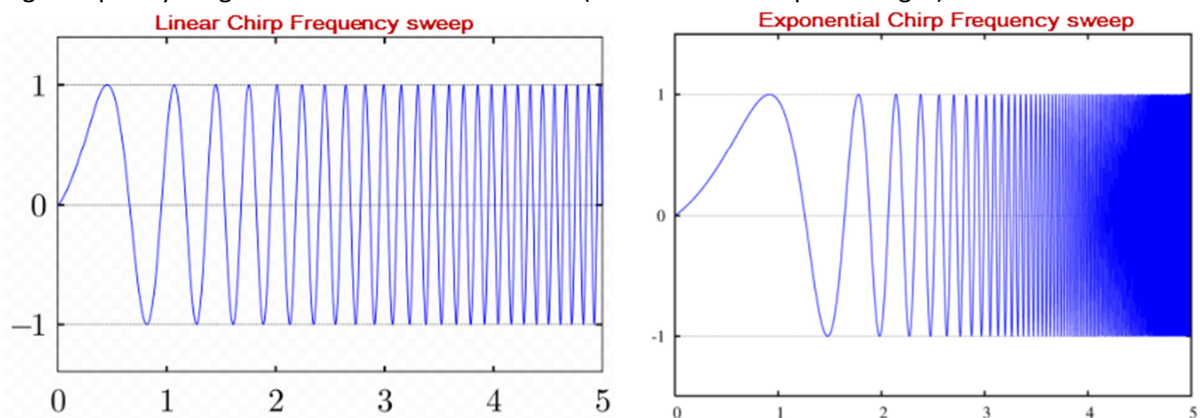

**Figure 26: Example of linear & exponential frequency sweep**

The Edgetech system produces a linear frequency up-sweep calibrated to generate a pulse spectrum with a Gaussian shape over the frequency range selected. The returns from these sonar pulses are then deconvoluted into a simpler acoustic format / intensity that is no longer frequency dependent.

### **SBP Sonar Resolution, Range and Penetration**

The sonar resolution in older single-frequency subbottom systems (i.e. 3.5 kHz) is determined by the pulse length of the transmitted waveform. In the case of Chirp subbottom systems, the resolution limit is determined by the bandwidth of the transmitted pulse. In theory, the resolution of a linear FM chirp system is:

$$\text{Pulse length} = \frac{1}{\text{bandwidth}} \quad \text{Range resolution} = \frac{\text{pulse length} \cdot \text{speed of sound}}{2}$$

Bandwidth	Pulse Length	Resolution
20 kHz	$\frac{1[s]}{20,000} = 0.00005 [s]$	$\frac{0.00005 [s] \cdot 154,000 [cm/s]}{2} = 3.85 [cm]$

The Sentry SBP Chirp system offers six user-selectable pulses with three different bandwidths / resolutions:

#### Egdetech SBP Pulses

- SB424\_4\_16\_10FM\_TSB.spf
- SB424\_4\_20\_5FM\_TSB.spf
- SB424\_4\_20\_10FM\_TSB.spf
- SB424\_4\_20\_10WB\_TSB.spf
- SB424\_4\_24\_5FM\_TSB.spf
- SB424\_4\_24\_10FM\_TSB.spf

#### Egdetech SBP manual for SBP424 system

Vertical Resolution <sup>1</sup>	4 cm, 4-24 kHz 6 cm, 4-20kHz 8 cm, 4-16 kHz
Penetration (typical) Coarse and calcareous sand <sup>2</sup>	2 m
Penetration soft clay <sup>2</sup>	40 m
Beam Width -3dB down (depending on the center frequency)	16°, 4-24 kHz 19°, 4-20 kHz 23°, 4-16 kHz

In general, as the bandwidth increases so does the resolution; however, frequency absorption and actual speed of sound in a given sediment strongly influences the resolution and penetration of sonar energy. Lower frequencies penetrate more while higher frequencies are absorbed faster. This impacts the signal bandwidth, effectively reducing resolution with sediment depth.

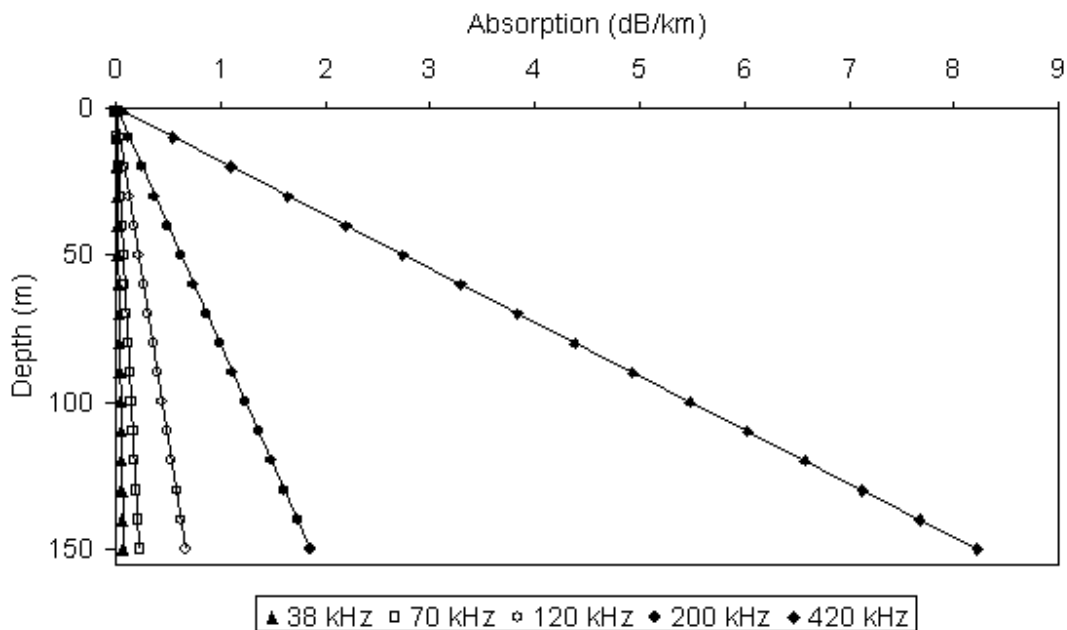

Figure 27: Absorption as related to acoustic frequency

The penetration depth of the SBP signal is defined as the maximum distance beneath the seafloor that a step change in density of 10% can be seen on the sub-bottom display. This value is dependent upon the amount of acoustic energy, the frequency of the energy and the sediment type. SBP sediment penetration for the Egdetech system ranges from ~2 m in coarse sands to 40 m in soft clays.

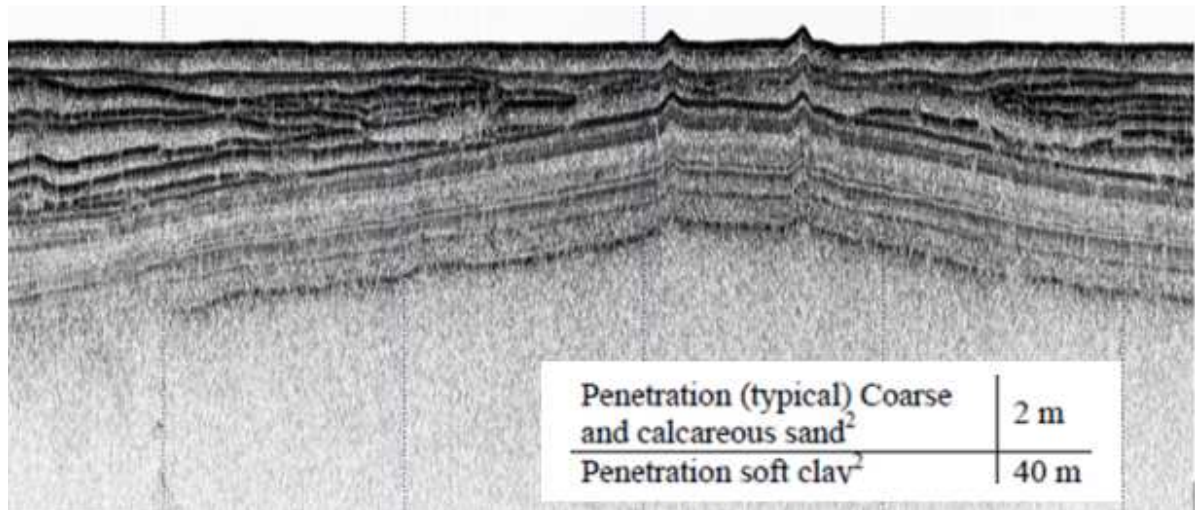

Figure 28: Example of subbottom data from *Sentry* (Image courtesy Christopher German)

### SSS Sonar Resolution and Range

The resolution of a sidescan system must be independently calculated for across-track and along-track directions. Along-track resolution is largely a function of survey speed, acoustic beam pattern, ping rate and sample rate. Across-track resolution (or range resolution) is largely a function of frequency, acoustic beam pattern and sample rate. For the sidescan system, target threshold must also be considered. If one pixel of data shows a high energy return, it is difficult to distinguish between an authentic feature and noise or scatter. With several adjacent pixels showing high energy returns, the target or feature is more obvious. Edgetech advertises the theoretical range resolution of the 120/410 kHz sidescan at 6.25 cm and 1.8 cm respectively.

The range of a sidescan system is somewhat arbitrary in that the signal to noise ratio varies widely depending upon the size and composition of the target and the environmental conditions (i.e. ambient noise level, electrical and mechanical noise levels, water conditions). The detection range is generally the point at which system noise levels start to compete with returned signal. In the case of *Sentry*, the background noise levels are minimal, allowing a greater range in which targets and bottom variations can be detected. Operating at deep ocean depths (> xxx?) in a less stratified, colder, more consistent water column decreases acoustic ray bending and absorption, improving two-way energy transmission.



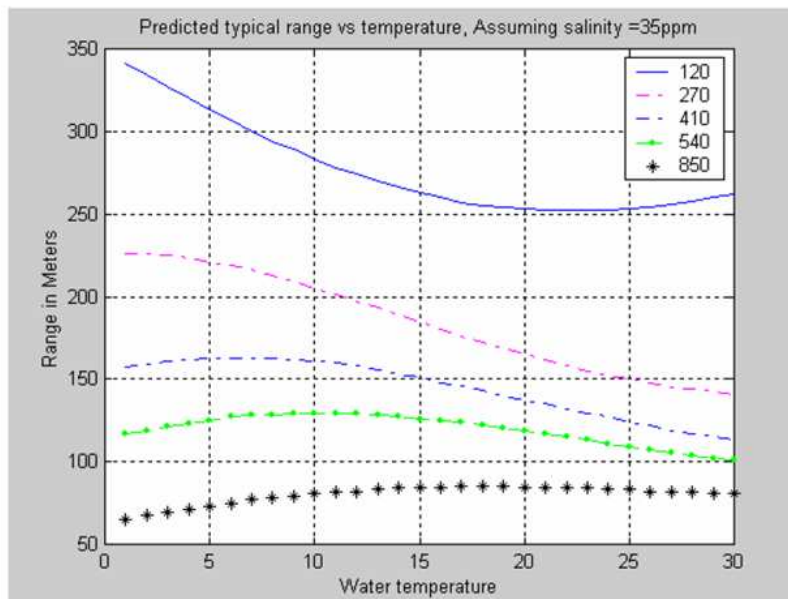

Freq : 75kHz, Range: 700 to 800m.  
 Freq : 120Khz, Range: 250 to 500m.  
 Freq : 270kHz, Range : 150 to 300m  
 Freq: 410kHz, Range: 130 to > 200m  
 Freq : 540kHz, Range: 100 to 150m  
 Freq : 850kHz, Range: 50 to 75m

Figure 29: Sidescan range related to frequency & water temperature

Edgetech advertises the “typical operational range” of their 120 and 410 kHz sidescan systems of 250-500 m and 130-200 m respectively. In practice Sentry’s 120 and 410 sidescan systems typically see ~300m range at 120 kHz and ~100m range at 410 kHz. However, this varies depending upon environmental conditions and vehicle configurations.

This review of the Sentry AUV Edgetech SSS & SBP sonars is intended to provide the end user with a basic understanding of what ranges & resolutions these sonars typically obtain, while providing enough background for the user to understand why these are not simple issues or constant solid values. Although ignored in the above discussion, there are many other factors that affect sonar systems resolutions:

- System tow speed, attitude and stability (i.e. pitching and rolling)
- Altitude of transducer / tow vehicle above the seafloor
- Electronic signal processing (signal-to-noise ratio and sampling rate)
- Horizontal beam width, side lobes, acoustic array quality / response
- Pulse smearing (multiples), where a system cannot distinguish between multiple pulses / reflections.
- Pulse stretching (acoustic foot-print); the larger the ensonified area, the more the return pulse will be stretched (i.e. a 1 ms pulse might be stretched to 1.5 or 2 ms when reflected back over a large area).

These factors can have significant impacts on sonar system performance or be completely negligible. Some of these factors can be optimized through proper survey planning, while some are basic design issues. The Sentry group endeavors to maximize data coverage and quality through equipment maintenance and assistance with survey planning.

## System Specifications

Full Spectrum Chirp Sub-Bottom Profiler		Full Spectrum Chirp Side Scan Sonar	
<b>Modulation:</b>	Full Spectrum Chirp Frequency Modulated Pulse with amplitude and phase weighting		<b>Modulation:</b> Full Spectrum Chirp Frequency Modulated Pulse with amplitude and phase weighting
<b>Source Level:</b>	200 dB re 1 $\mu$ Pa at one meter		
<b>Transmit Power:</b>	200 watts		
<b>Receive Sensitivity:</b>	-204 dB re 1 $\mu$ Pa at one meter		
<b>Receiver Variable Gain:</b>	38 – 105 dB, automatic or manual control		
<b>Noise Level:</b>	70 dB re 1 $\mu$ Pa at one meter over sonar bandwidth (at hydrophone input)		
<b>Pulse Repetition</b>	15 Hz maximum		
<b>Sensor Model:</b>	DW-424		
<b>Frequency Band:</b>	4 – 24 kHz		
<b>Number of Hydrophone Arrays:</b>	2		
<b>Pulse Selections:</b>	4-24 kHz / 10 ms 4-20 kHz / 10 ms 4-16 kHz / 10 ms		
<b>Resolution:</b>	4 – 8 cm.		
<b>Beam Width:</b>	15° - 25°		
<i>Weight in Air</i>	<i>Weight in Salt Water</i>		
<b>Transmitter with Bracket:</b> 10 kg	<b>Transmitter with Bracket:</b> 4.3 kg		
<b>Hydrophone Array with Bracket:</b> 6 kg	<b>Hydrophone Array with Bracket:</b> 3.2 kg		
<b>Transmitter Alone:</b> 7 kg	<b>Transmitter Alone:</b> 4 kg		
<b>Hydrophone Alone:</b> 0.9 kg	<b>Hydrophone Alone:</b> 0.2 kg (each)		
		<b>Dual Frequency</b>	120/410 kHz
		<i>Common</i>	
		<b>Vertical Beam Width:</b>	70°
		<b>Depression Angle:</b>	10°, 15°, 20° from vertical, adjustable
		<b>A/D Resolution:</b>	16 bits
		<b>Sample Rate:</b>	940 K samples per second
		<i>Frequency Specific</i>	
		<b>Center Frequency:</b>	120 kHz      410 kHz
		<b>Pulse Bandwidth:</b>	12 kHz      41 kHz
		<b>Pulse Length:</b>	8.3 ms      2.4 ms
		<b>Range Scale Selection:</b>	25 – 500 m.      12.5 – 100 m.
			per side      per side
		<b>Maximum Ping Rate:</b>	30 pps      60 pps
		<b>Range Resolution:</b>	6.25 cm.      1.8 cm.
		<b>Horizontal 3dB Beam Width:</b>	0.8°      0.5°
		<b>Transmit Power:</b>	200 Watts      160 Watts
		<b>Peak Source Level:</b>	210 dB      216 dB
			(ref. 1 $\mu$ Pa @ 1 meter)
		<b>Receiver Sensitivity:</b>	-190 dB      -196 dB
		<i>Transducers - Physical</i>	
		<b>Combination:</b>	120/410 kHz
		<b>Size:</b>	6.4 W x 6.4 D x 99.1 L (cm)
		<b>Weight in Air:</b>	27.7 kg
		<b>Weight in Salt Water:</b>	14.7 kg

Figure 30 - Edgetech 2200M specification from the Edgetech website

## **Appendix C – Ship Selection Guidelines**

### **Basics**

The AUV *Sentry* is specifically designed to operate from a ship of opportunity and to be as flexible as possible in the ships it operates from. Despite the emphasis on portability and flexibility, significant care is still required in ship selection to ensure safe and effective operations.

The basic requirements involve space, crane, and access to the water. Space is required for two 20ft shipping containers including one on the main deck, the *Sentry* cradle, and several pieces of deck cargo. Lab space of at least 30 linear feet of bench is required. A crane capable of dealing with 3500lb static loads and 10,000lb dynamic loads at a distance of 20+ ft from the side of the ship is required. A safe and effective means of putting *Sentry* in the water and recovering it later must be devised. This generally dictates a modest freeboard in at least one place on the side of the vessel near the pitch center and as far from the props as possible. Roll stabilization is helpful as it increases the operable weather window.

Beyond the physical requirements that the ship be able to accommodate the equipment, it is also necessary that the crew be experienced in launch and recovery of delicate equipment such as AUV's moorings, buoys, or gliders. The ability to lay a ship alongside a floating object and stand off from that object at a desired distance during deck operations despite currents, waves, or winds is critical. A skilled crane operator used to dealing with minimally arrested loads on long booms while at sea is critical to safe operation of the vehicle. Both hand and powered tag lines are used as much as possible, but are not fool proof. *Sentry* personnel are not trained to operate cranes and we rely on the vessel to provide an operator.

We can operate readily from both DP and non-DP vessels in a wide variety of sizes. We have operated from UNOLS and non-UNOLS vessels and both US and foreign vessels. Often even if a ship is not ideal, we can still make it work, but additional mob and demob time may be required, additional equipment may be required, and if we haven't worked from the vessel before, a visit to the ship ahead of time will be required. Depending on your funding source, some or all of this will have to be included in your proposal budget. For NSF, NOAA, and ONR, you do not need to budget for these costs.

### **Details**

The information above is meant a first pass evaluation of a ship. Critical details are given below. The most critical thing to work out is a safe and effective launch and recovery. Typical procedures are given in Appendix F – Sea Going Staff.

#### **Ship Propulsion Requirements**

*Sentry* is designed to operate on both Dynamic Positioning (DP) and non DP ships. The critical element is that the combination of propulsion and ship's crew should be able to lay the ship alongside a free floating object with close to zero relative motion and maintain this position for several minutes while objects are retrieved from the water. A willingness to secure the prop on the launch and recovery side during deck operations is highly desired.

#### **Deck Space:**



- 2 standard 20ft ISO container 20x8x8.5ft (LxWxH) Up to 25,000lbs. One of these will need to be on the main deck, the other can be in an alternate location.
- 1 *Sentry* Cradle (approx 3 meters by 2 meters plus working space) ~ 3500 lbs – See Figure 31 and Figure 32
- 2-3 weight stacks approximately 36x18x12in (hwxwd) ~ 3000 lbs each
- 1-Pallet Box: 48x46x32in (LxWxH)
- 1-USBL system (see USBL section below)

#### Access and layout considerations

- The main van container has double doors aft, and a personnel door forward right. The van can be oriented as needed, but both the double doors, and the entire side of the van with the personnel doors should be free from obstruction for ~ 2meters and should not be considered a walkway. Both areas should be shielded from the weather to the maximum extent possible. The main van also has power, air conditioning, and cable pass through forward left which must be accessible. 480V three phase power is required to this van.
- The second van as double doors aft which must be accessible while underway. Some safe means of moving packages weighing up to 200lbs between this van and the main deck must exist.
- The cradle should be positioned within easy reach of an appropriate crane (see Crane & Rigging Requirements)
- Frequent and ready access to all sides of the vehicle is required for maintenance, and it is desirable not to have walkways routed near the vehicle as there are several protruding parts and the potential for portions of the vehicle to be moving. It is necessary to the launch and recovery process that at least 5 ft fore and aft of the cradle be clear of obstruction as well as a space inboard where an air tugger can be stationed (though turning blocks are possible).
- The van on the main deck needs to be within an 80 ft cable run (min 4 in dia of open space) of the USBL pole and within a 70ft run of the vehicle.
- Weights from the weight stack will need to be carried to the vehicle prior to every dive and are heavy. Maintaining minimum distance is desirable.
- A 15KVA service (480V/60Hz three phase) is required for the shipping container.

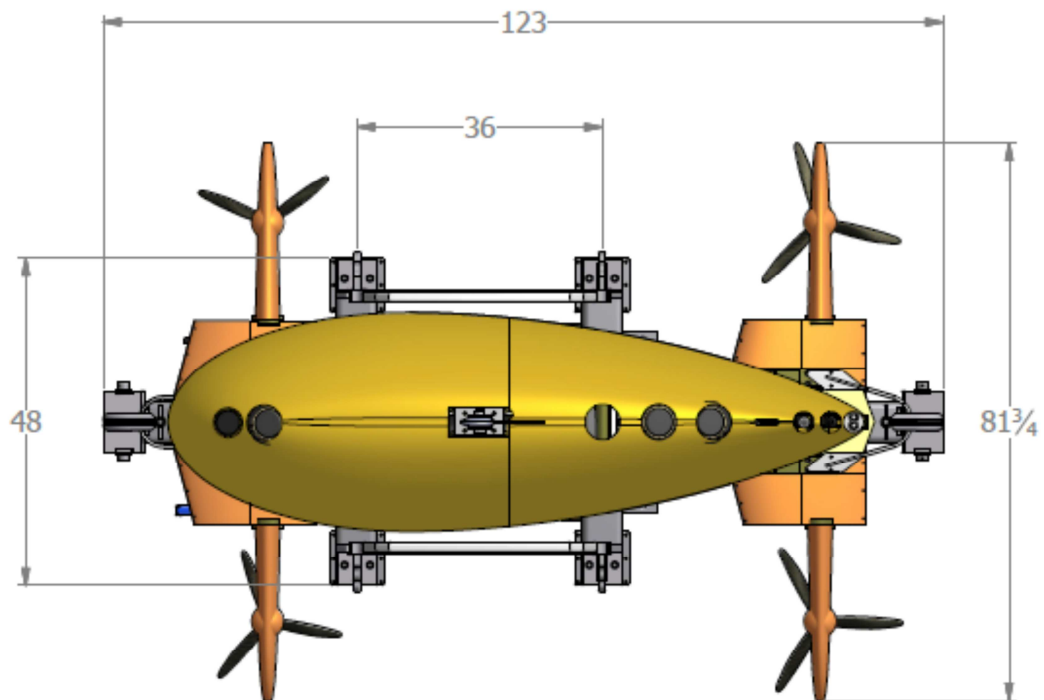

Figure 31 - Plan view of the *Sentry* Cradle. Note that an additional 4 – 6 feet of open space is required to fore and aft and 3-4 feet to each side as a work and launch and recovery area.

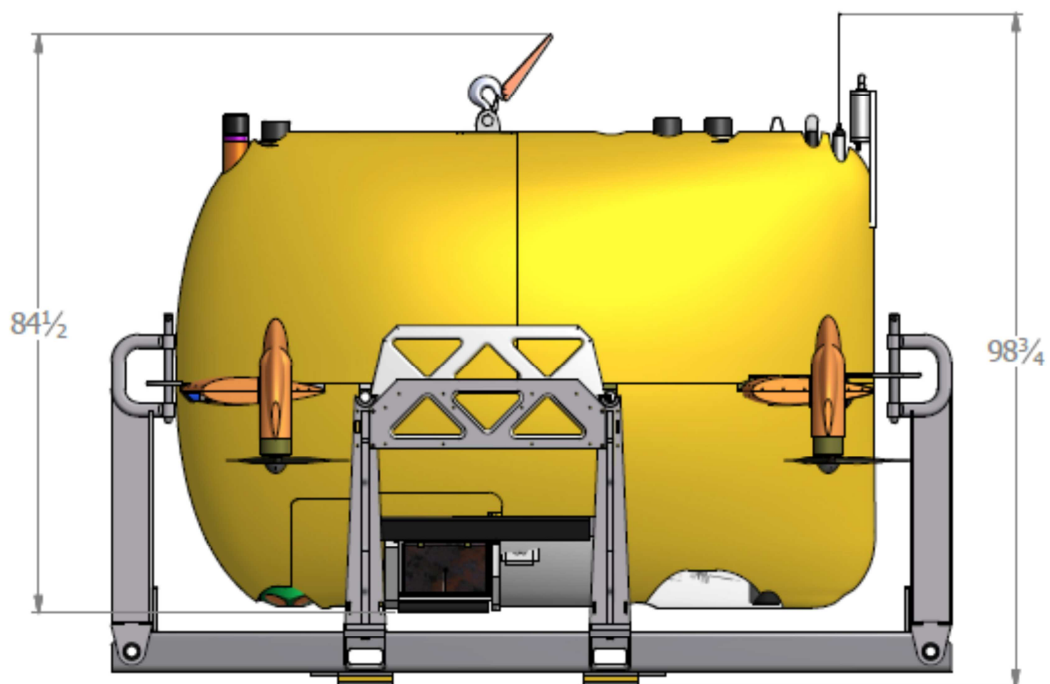

Figure 32 – Side view of *Sentry* in the cradle.



Figure 33 - Typical location of the *Sentry Cradle*. Note the cables running from the wall to the vehicle, the ample work room around the vehicle, and the proximity to the side of the ship relatively close to the water.



Figure 34 - Weight stacks secured to the side rail of a ship

### Lab Space

*Sentry* has a very high computing and data processing load requiring space and power for 5 - 10 PC's and laptops as well as the need for repair and maintenance spaces, battery charging station, navigation station, and printer. The typical minimum required facilities are

- 2 sit at data processing desks or benches, minimum 5ft long each with chairs
  - Each should have at least a 2KVA service (110V/60Hz preferred 220/50Hz ok)
  - These will tend to be high traffic areas and should be close to lab entrances

- 2 sit at work areas, minimum 4 ft long each with chairs
  - Each should have access to electrical power
- 1 stand at repair bench, minimum 6ft long
  - Should have access to electrical power
  - Should be removed from the flow of traffic and close to the data processing stations if possible
- 1 sit at navigation station, minimum 6 ft long with chair
  - Need electrical power

The *Sentry* group will set up its own subnet for its computing system so that it can be rapidly isolated in the event of problems, however, at least one (preferably static) IP address will be needed on the ships network, and it may be desirable to have additional addresses for personal laptops. Internet access will be required (see below).

### Storage Space

If available, 10 – 15 cubic meters of hold space for empty packing cases and boxes while at sea is very helpful.

### Ships data

We often use information from the vessel's data system to support the real-time navigation of the vehicle. Data items needed include vessel position from the shipboard GPS receiver and the vessel heading from the ship's gyro. Note that the vessel direction of travel provided by GPS is not a substitute for the vessel gyro heading.

### GPS

The GPS data should be furnished as an RS232 NMEA serial string on a conventional serial line. We use the GPGGA string, and the minute field should have at least 4 decimal places. NMEA convention is for 4800 baud, we can accommodate any standard baud rate. Typically this GPS feed will need supplemental GPS such as WAS or the local equivalent in order to achieve good navigation on the seafloor.

Alternatively we will often place our own GPS antenna on the ship at a convenient location, typically on a rail aft of the bridge and several decks above the main deck.

### Gyro

We use the HEHDT or GPHDT strings from the ships gyro. These provide the vessel's true heading independent of the direction of travel. Note that strings like GPVTG, which provide the vessel track made good, are not suitable for this purpose. The data must come from a heading reference such as an INS or gyro not the GPS alone. As for the GPS, we can accommodate any standard baud rate. The data can come in on a separate serial line or it can come on the same line as the GPS data.

We can accommodate either DB25 or DB9 connectors of either gender. If you use other connectors (RJ-45, etc) please provide us with adapters for DB9 or DB25.

We can deal with other formats if they are properly documented and we get some prior notice. We suggest that these lines be tested with a simple ascii terminal program (hyperterm for example) before we arrive.

### USBL/LBL

*Sentry* Utilizes an Ultra Short Base Line (USBL) or a Long Base Line system for subsea navigation. From a ships perspective, the primary requirements for either system are a GPS feed, and the ability to place a transducer in the water in a repeatable location that is unshadowed by the hull in all directions. Over the years we have used a number of options for mounting this transducer, but the most common is a swinging pole (see drawing) that is lowered by a ships crane during operations and can be pulled up during transits. This also provides acoustic communications and other similar infrastructure.

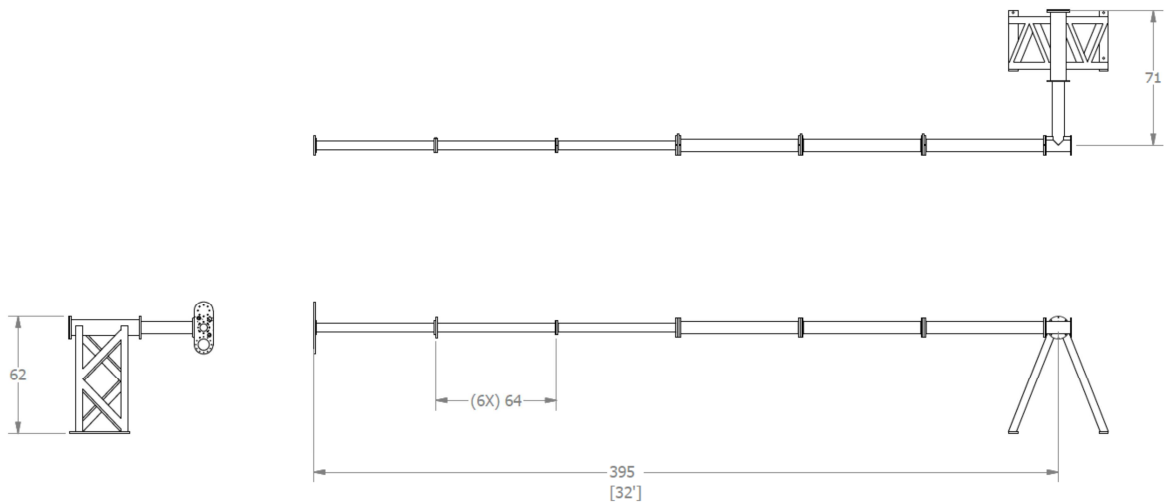

**Figure 35 - Overall USBL Dimensions**

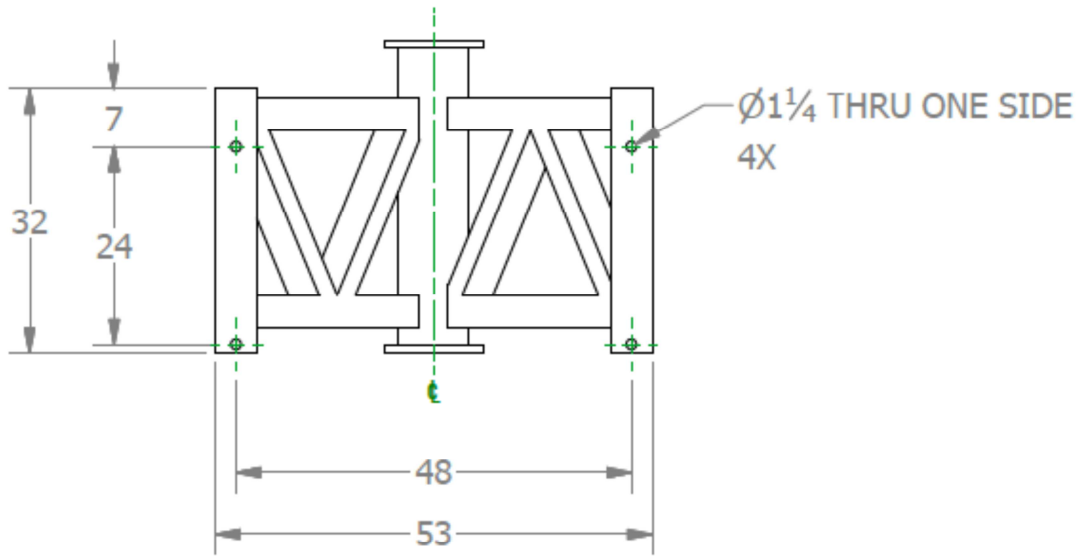

Figure 36 - USBL Base Bolt Pattern



Figure 37 - USBL pole retracted and secured in the stowed position. To deploy, a crane is used to hold the near end, the assembly slides outboard relative to the base, and is rotated clockwise into the water where it is locked in the down position.

### Berthing

The *Sentry* group requires berthing and other standard accommodations for five crew members. If additional bunks are available we may occasionally request one to assist in training or for a student. If additional crew members are requested for operational reasons, additional bunks will be required.

## Ships Equipment and Services

Depending on the ship configuration, *Sentry* often uses one or two air tuggers as swing arrestors. Each of these air tuggers requires 50scfm (1.4m<sup>3</sup>/min) at 90psig (6.3 bar) and utilizes a 3/4in (19mm) air hose

*Sentry* contains several components that are susceptible to salt crystal accumulation. Adequate fresh water for a thorough rinse after each dive is required.

## Crew Assistance

*Sentry* is designed to operate with a small operations group and consequently relies on the ship's crew for assistance during mob/demob and deck operations. At a minimum a crane operator, spotter, and bridge liaison are needed for every deck operation. *Sentry* has individuals qualified to operate as deck boss during deck operations, but we prefer to have a very experience member of the ship's crew directing overall deck operations in close coordination with *Sentry* personnel.

During Mob and Demob, assistance will be required with moving and securing all items listed on the deck space requirements. Assistance will be required with integration to ships data feeds and networks. Assistance will be required with routing of cables and tubing.

## Crane, Rigging & Handling Requirements:

The most difficult and dangerous portions of *Sentry* operations are launch and recovery. Launch & recovery of *Sentry* is very similar to launch and recovery of other science gear that is set free of the ship (not attached by wire). One of the differences is that it has fragile projections such as thrusters and wings, science instruments, flashers and a radio antenna that could be damaged if *Sentry* comes in contact with the ship, especially on recovery. The other difference is that during recovery *Sentry* usually has the capability of being driven on the surface by radio control. This allows the ship to come to a stop a comfortable distance from the vehicle (typically 50 – 100 meters depending on conditions), get stabilized to the wind and seas, and then have *Sentry* come to the ship. This capability can fail and the ship should be prepared to recover the vehicle safely without this capability.

*Sentry* weights about 3000 pounds (~1360 kilos) and roughly measures 10 ft (3m) long, 7.2 ft (2.2m) wide and 6 ft. (1.8m) tall. It is lifted from a single point on top and there are two primary tag line attachment points. It rests in a custom cradle, which is secured to the deck during operations. *Sentry* does not use a formal swing arrestor and can have significant cable length below the boom of the crane requiring a skilled crane operator.

Standard procedures for launch and recovery including images are available in Appendix F – Sea Going Staff. A video is available on the *Sentry* website which shows the majority of a launch and recovery. Note that these pictures are all in a very calm sea state but *Sentry* can and regularly does operate in rougher weather. Specific weather parameters are determined on a case by case basis for each ship. General weather guidelines are given in Weather Windows and Considerations.

## Internet

Internet access has become a core part of the *Sentry* operation and will need to be available to computers on the *Sentry* network. We work hard to be self sufficient and minimize data use, but we have come to rely on the wealth of online knowledge when trying to implement a new capability or fix a problem. Your results will be substantially reduced without internet access. We are used to working with slow connections such as High Seas Net.

## **Previous Vessels**

*Sentry* has operated on a number of different vessels over the years. A list is below along with any complications which required additional time or resources during the mobilization and or demobilization. Ordering is alphabetical.

- R/V Atlantis
- R/V Brooks McCall
  - Crane unacceptable
  - Vessel not to be used again
- R/V Endeavor
- R/V Knorr
- R/V KoK
  - Slow Crane
  - Substantial Roll
  - Requires equipment to be welded to deck
- NOAA Vessel MacArthur II
  - Requires equipment to be welded to deck.
- R/V Melville
- R/V Merrian
- E/V Nautilus
  - Cannot place van on main deck
  - Can only place one van
  - Insufficient lab space
  - 360V power instead of 480
  - Requires custom track on deck
- R/V Oceanus
- NOAA Ship Okeanos Explorer
  - Insufficient lab space
- R/V Roger Revell
- R/V Tangaroa
  - Extremely high freeboard for most of working deck
  - Can only place one van
  - Requires equipment to be welded to deck
- R/V Thompson



## **Appendix C – Launch and Recovery Procedures**

Launch and recovery of *Sentry* is similar to launch and recovery of many forms of science gear free of the ship that are launched and recovered by research vessels around the world. *Sentry* sets itself apart from a lot of deployed science gear by the various sensors, Sonar's, and tracking equipment that are on the outside of the vehicle. This equipment is exposed and venerable on launches and Recoveries and particular attention should be paid to avoid damaging this equipment. *Sentry* also has a unique capability that allows an operator to drive *Sentry* to the ship. This allows the Vessel to comfortably hold the ship on station while the vehicle drives to the recovery location.

Figure 1 is a picture of *Sentry* on the DECK of R/V Knorr. This picture has the *Sentry* umbilical and charge cables attached as well as the cooling lines.



Figure 38

### **LAUNCH AND RECOVERY PREPARATION**

#### **General Safety Awareness**

Personnel safety is the number one concern for *Sentry* Operations. *Sentry* Operations combines the Vessels Safety Guidelines, WHOI's Safety Guidelines as well as UNOLS RVOC Safety Guidelines to provide safest operations environment possible.

#### **On Deck Personnel**

*Sentry* Launches and Recoveries require the following deck support

- Deck Boss/Launch Coordinator (typically BOS'N or *Sentry* crew)
- Crane Operator (Ship Personnel)
- Line Handlers - Minimum 3 Persons (Filled by Deck Crew/*Sentry* Crew)
- Pull Pin Handler (*Sentry* crew, only required for Launch)

### Personal Protective Equipment

*Sentry* Operations requires at a minimum the following PPE (Personal Protective Equipment) during Launch and Recovery Operations.

- Hard Hat
- Coast Guard Approved Work Vest
- Closed toed shoes (preferably steel toes)
- Gloves (Optional)
- Safety Glasses (Optional)

### **NORMAL OPERATING CONDITIONS**

#### Vessel Setup

Vessel setup is a key component to *Sentry* launch and recovery operations.

- During launch the critical consideration is that the vehicle not pass under the ship. To this end, the ship will need to set up into the seas to minimize roll, but with the side of the ship where launch will occur as down current as possible.
- During Recovery, the key issue is not to impact the vehicle. Since *Sentry* can drive towards the vessel, it is better to set the vessel up downwind of *Sentry* so that it is blown away from *Sentry*. It may be necessary to move the ship's bow a little after the lift line is hooked up and before the crane lifts *Sentry* from the water as the prime consideration then becomes minimizing roll.

#### Sentry Launch

*Sentry* is ready to be launched after the *Sentry* crew conducts a successful deck test of the vehicle. The *Sentry* launch coordinator crew will coordinate launch time and position with the necessary Vessel crew. The following is the general flow of launch operations for *Sentry*. Some of these actions will happen simultaneously.

- Notify Deck personnel of Launch time and ensure all necessary jobs are filled.
- Secure tag lines to *Sentry* fore and aft
- Rig air tugger line to crane hook
- Rig lifting sling with pull pin and crane hook
- Radio Beacon on and tested, Strobe on and Tested
- Charge and umbilical cable are removed from *Sentry*
- Secure all panels on *Sentry*
- Cooling lines are removed

NOTE: On launch Tag Line handlers shall pay particular attention to entanglement of the lines, particularly when slipping the lines. The unique design of *Sentry* creates various hazards for tag lines to get caught and create damage to the vehicle. Tag lines need to stay clear of the Vehicle fins, thrusters, and sensors on the top of the vehicle. In particular, tag lines must be slipped gently and not allowed to swing freely. The recommended procedure is to slack the line and slip it until the free end is in one hand. This can then be dropped into the water to arrest line swing and gently pulled hand over hand by the other end.

*Sentry* Launch will commence with lifting the vehicle several inches

- The poles used to hold *Sentry* up will be removed
- The fore and aft catches will be removed
- *Sentry* shall then be lifted out of the cradle up to a height that will allow *Sentry* to clear the Vessels railing
- *Sentry* should then be moved outboard to position it above the water and a safe distance from the ship.
- Slip the bow tag line as the vehicle goes over the rail. Recover as much of stern tag line as possible in preparation for slipping it.
- Orient the vehicle pointed away from the ship (*Sentry* may glide forward as it descends).
- Start lowering the vehicle into the water AND slip the stern line. Ideally, the stern tag line is free of *Sentry* when it just touches the water but err on the side of clearing the tag line.
- Pull the release (as soon as weight is off lift sling) and lift crane hook up and away.
- If necessary slide ship away from vehicle as it descends clear of the ship. Then slowly move ship clear of *Sentry* by several hundred meters in case it should surface prematurely. Typically the *Sentry* launch coordinator will provide direction over the radio.
- Secure crane and all launch equipment.
- Have ship remain within tracking distance until *Sentry* is following mission profile adequately

### *Sentry* Recovery

Provide bridge with expected time and location for *Sentry* to be on the surface. Ship should typically be positioned about 400 meters down wind of *Sentry* as it approaches the surface. It is critical to be tracking *Sentry* as it leaves the bottom since tracking is poor as it gets near the surface and hard to pinpoint its location.

There are two recovery scenarios:

*Sentry* is able to be driven on the surface towards the ship using radio control.

*Sentry* is “dead boat” and the ship must maneuver along side of *Sentry*

- Ensure all required personnel are present and notify bridge that the deck personnel are ready for recovery of the vehicle.
- Ship should approach *Sentry* to within 50 – 100m meters off the rail of the ship near the recovery location. *Sentry* personnel will attempt radio control with remote control box. If radio control is obtained, ship should come to a stop and hold position and heading that they feel is best. When bridge has ship in position and is ready they should notify the deck to have *Sentry* driven to the ship.

If *Sentry* is NOT radio controlled then the ship should carefully approach *Sentry* trying to keep it off about 10-15 ft until alongside and within pole reach.

- When *Sentry* is alongside the ship in the area for recovery, a long pole attaches the lift line loop to the lift hook on *Sentry*. The lift line is pulled free of the pole and the loop at the other end is QUICKLY attached to the crane. Under some circumstances the lift line may already be attached to the crane. A tagline running directly inboard to an air tugger will typically already be attached. IT IS IMPORTANT THAT THE PEOPLE ON THE STABILIZING TAG LINES KEEP THE LIFT LINE FROM TANGLING ON *Sentry*. This can be done by keeping some tension on the lines thus lifting the lift line up and clear of the vehicle.

- As soon as the lift line is attached the crane should swing outboard to keep *Sentry* from hitting the hull. Note that if the crane pulls *Sentry* sideways it may slip forward or aft (direction of least resistance) through the water, and thus impact the hull. The pole can be used to push *Sentry* away if necessary.
- As *Sentry* comes out of the water the crane should bring it inboard enough to attach tag lines. These lines attach to the **appropriate** “D” rings welded to the struts between the upper & lower hulls.
- Continue to bring *Sentry* onboard and lower until just above the cradle
- Capture *Sentry* with fore and aft constraints
- Replace outboard leg of cradle and insert poles
- Lower *Sentry* into the cradle
- Secure the vehicle with cargo straps and disconnect all lines so the crane can be secured.

## Launch and Recovery Pictures and Sequence

### Launch



Figure 39 - *Sentry* is in the cradle and lifted approximately 1-2 inches





Figure 40 - The outboard side of the cradle is removed and the pipes through the center of the vehicle are removed.

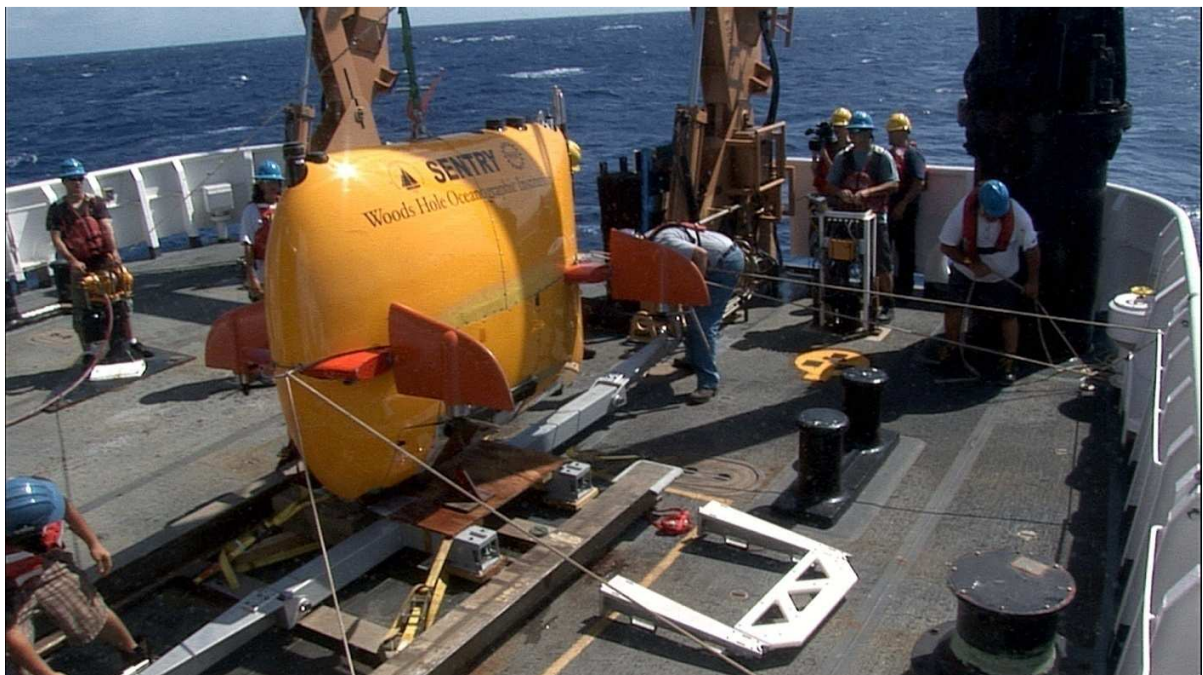

Figure 41 - The fore and aft catches are released leaving the vehicle stabilized by the tagline to the air tugger (left) and the fore and aft taglines (right)



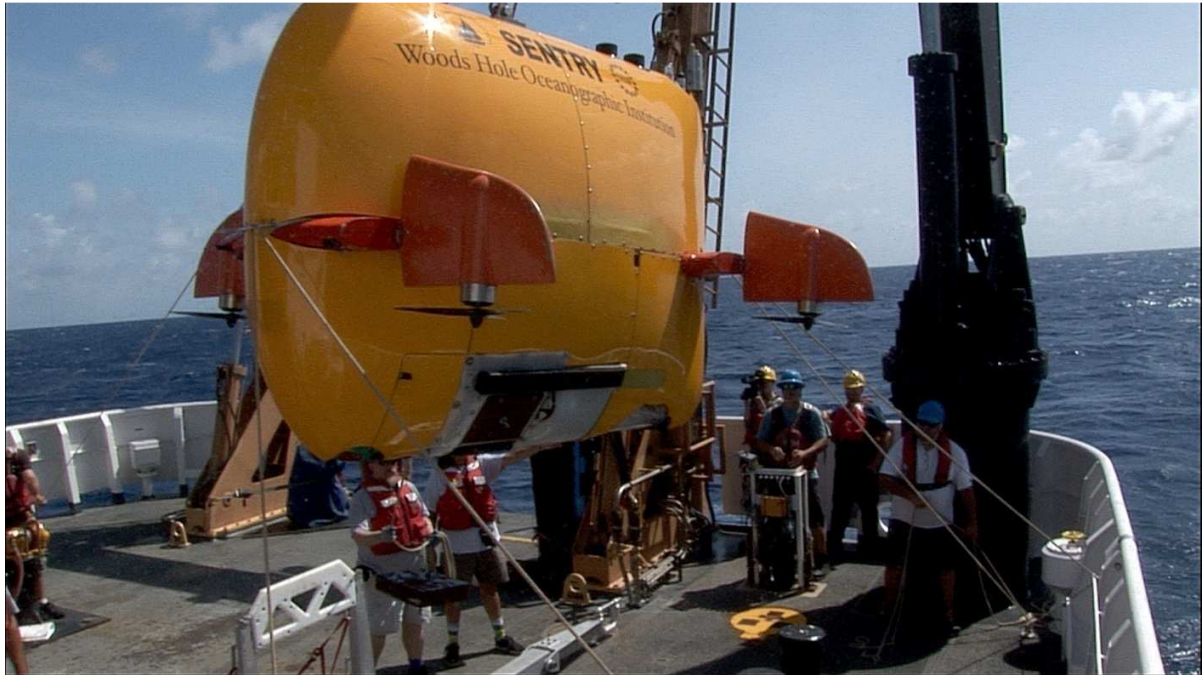

Figure 42 - *Sentry* is lifted up from the cradle and out towards the rail.



Figure 43 - As *Sentry* moves over the rail, the forward tagline is slacked and slipped.



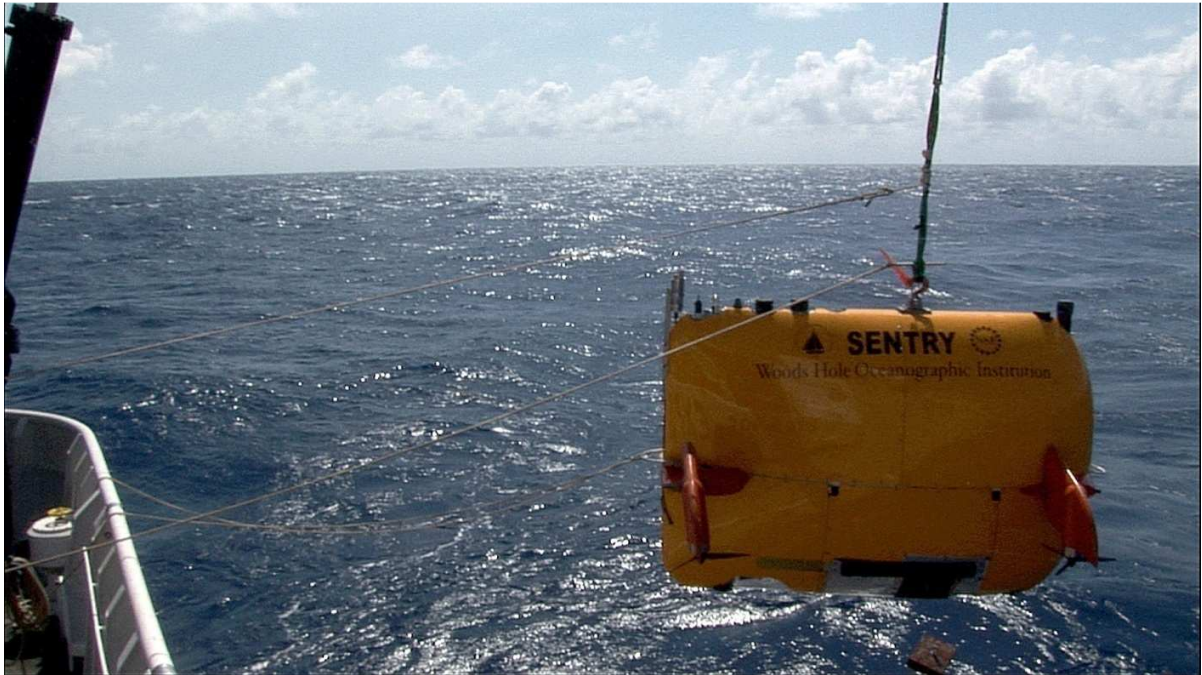

Figure 44 - *Sentry* continues to move outboard, the aft tagline is used to point the vehicle away from the vessel, then is slipped right before the vehicle enters the water. As soon as the pin is unloaded, it is pulled and the vehicle descends freely.



Figure 45 - As the vehicle drives towards the stationary vessel, the lift line for the crane is attached using a carbon fiber pole. The vehicle immediately drives full reverse and the pole is potentially used to fend the vehicle while the lift line is tensioned.



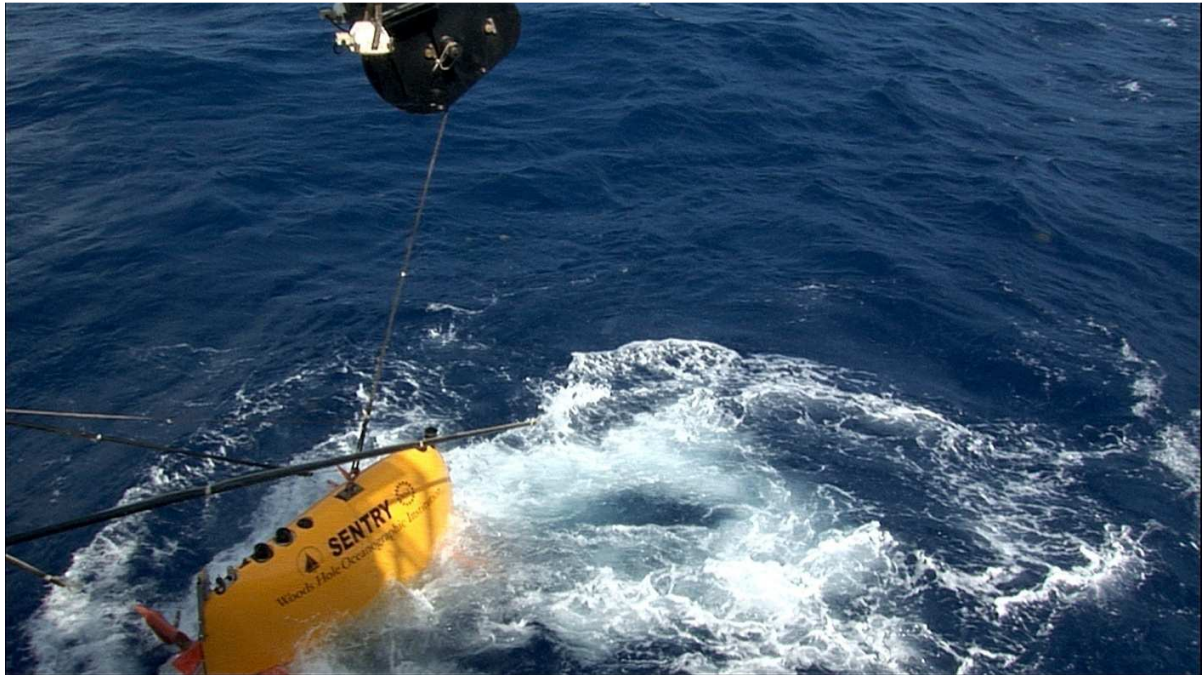

Figure 46 - As the lift line is tensioned and the vehicle lifted partially out of the water, fore and aft tag lines are attached using carbon poles and hooks. The tagline to the airtugger is already attached to the lifting bridal.



Figure 47 - The vehicle is slewed back into the cradle and the fore and aft catches are secured first. The side is reattached and the poles reinserted before the vehicle is set into the cradle.



## **Appendix D – Points of Contact and Resources**



### **Sentry Project Manager**

Dr. Carl L Kaiser  
(508) 289-3269  
ckaiser@whoi.edu

BS, MS, and PhD in Mechanical Engineering at Colorado State University with an emphasis in Robotics. Research Interest include autonomous vehicles of all types but especially adaptive systems which are able either to change missions seamlessly in response to sensor inputs or abstract commands from human operators or which are able to continue part or all of a mission despite significant failure(s).



### **Chief Scientist for Deep Submergence**

Dr. S. Adam Soule  
(508) 289-3213  
ssoule@whoi.edu



### **Director of the National Deep Submergence Facility**

Andrew D. Bowen  
(508) 289-2643  
abowen@whoi.edu

B.S. in Mechanical/Ocean Engineering from University of Rhode Island in 1980. Andrew is the Director of the National Deep Submergence Foundation. His research interests include; remotely operated submersibles, propulsion systems, application of close loop control of remotely operated vehicles, and introduction of remotely operated systems for oceanographic research.



### **NDSF Operations Manager**

Catherine Offinger  
(508) 289-3445  
coffinger@whoi.edu

B.A. Skidmore College, 1973, in English. She is currently in charge of organization and logistics support for un-crewed vehicle teams including *Jason*, *Nereus* and *Sentry*.



### **DSF Data Manager**

Scott McCue  
(508) 289-3462  
smccue@whoi.edu

Remote sensing using satellite-derived data; software development; underwater instrumentation; underwater acoustics.

## **Appendix E – Pre Cruise Questionnaire and Checklist**

### **Data You Need to Provide**

\_\_\_\_\_ Ship Bathymetry for your site

\_\_\_\_\_ Data is a GMT Grid or SD object?

The coordinate system for my data is \_\_\_\_\_(WGS84 preferred) Please note that jpegs, gifs, or raw swath data will not work. If you don't have the coordinate system, we can use the data.

### **Data to be Handed to You**

How do you want your data drive formatted?

\_\_\_\_\_ EXT3 \_\_\_\_\_ EXT4 \_\_\_\_\_ NTFS

Do you want additional copies of the data? How many \_\_\_\_\_

\_\_\_\_\_ Have you provided the appropriate blank drives? It is very important to provide the correct blank drives. Please consult with us ahead of time or see Data and Data Handover. Please note that depending on your cruise, you may not be able to purchase the necessary drives in a retail store, it may be necessary to order them online.

### **Sensors You Will Need**

Do you plan to use any custom sensors on *Sentry*? \_\_\_\_\_ yes \_\_\_\_\_ no

If you marked yes, please contact us immediately.

While we generally will have all sensors available, please let us know the status of each system for your cruise:

<b>Sensor</b>	<b>Critical</b>	<b>Desired</b>	<b>Not Needed</b>
Multibeam			
Sidescan			
Sub Bottom			
Magnetometers			
Camera			
CTD			
Turbidity			
Dissolved Oxygen			

Do you plan to request the use of the Ko-Ichi eh probe? \_\_\_\_\_ yes \_\_\_\_\_ no

## **Appendix F – Sea Going Staff**

## **Appendix G - Acoustic Devices: Frequencies & Power**

Sentry utilizes a substantial number of acoustic devices. The most common devices are listed here [Figure 48]. Not all of these devices are installed for every device, but if filling out permit applications, we recommend that you either include all of them on the permit or discuss with us ahead of time to select a narrower list.

<b>Device</b>	<b>Frequency</b>	<b>Manufacturer</b>	<b>Frequency can be changed</b>	<b>Max Power</b>
Doppler Velocity Log	300kHz	TRDI	No	216 dB
Doppler Velocity Log	1200kHz	TRDI	No	214 dB
Reson Multibeam Sonar	200/400kHz	Reson	200kHz or 400kHz only	220 dB
Longbase Line Tracking	10.5,13.0,14.0,9.0,10.0,8.5,11.5,9.5,8.0 kHz	WHOI/Benthos	Yes	
XR emergency releases	8-14kHz	WHOI/Benthos	Yes	
Ultra Short Baseline	26.5,19,27,29 kHz	Sonardyne	Yes	193 dB
Sub-bottom Profiler	2-24kHz	Edgetech	Various chirps within that range	210 dB
Side-scan sonar	120kHz & 400kHz	Edgetech	No	210 dB
Altimeter	500kHz	Valeport	No	211.5 dB
USBL	21.0,24.0,28.75,29.25,21.5	Sonardyne	Yes	193 dB
Imaging Multibeam	900kHz	Blueview	no	206 dB

Figure 48 - Sentry Acoustic Devices: Frequencies and Power

## Appendix H – Dive Weights

*Sentry* utilizes dive weights both for descent and ascent. Some dive weights may also be used to deploy temporary moorings for navigation purposes. All moorings are recovered prior to the end of the cruise, but dive weights and mooring anchors are left on the seafloor. All dive weights and anchors are made primarily of “Alvin plates” [Figure 50]. Alvin plates are made of flame cut mild steel and are not painted or surface treated. Three configurations of weights may be left on the seafloor:

- *Sentry* descent weights
- *Sentry* ascent weights
- Navigation Mooring Anchors

Weight Type	Rate of Use	Typical Frequency
Sentry Descent Weight	1 per dive	1 per 24-48 hours on station
Sentry Ascent Weight	2 per dive	2 per 24-48 hours on station
Navigation Mooring Anchor	<ul style="list-style-type: none"> <li>• 1 per USBL calibration</li> <li>• 1 per navigation mooring</li> </ul>	<ul style="list-style-type: none"> <li>• 1 per cruise</li> <li>• Rarely used at all, but if used, 3 per geographic area</li> </ul>

Figure 49 - Typical Weights Abandoned in Place During Operations

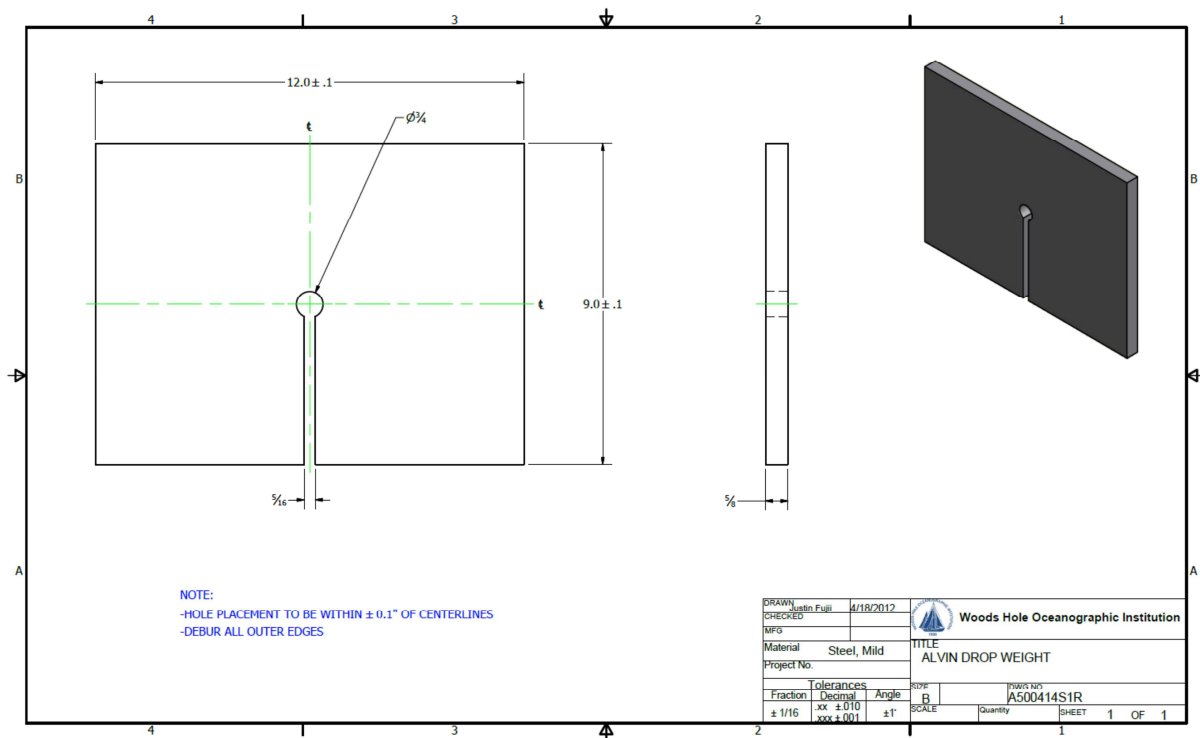

Figure 50 - Sentry Dive Weight

### Sentry Descent Weights

One *Sentry* descent weight is used per dive. A *Sentry* descent weight is composed of:

- 4x Alvin plates

- 1x Galvanized steel eyebolt with shoulder and nut: 3.25inX½-13 thread (McMaster part number 3018T17 or equivalent)
- 1x Stainless steel shackle: 1/4in (McMaster part number 3898T12 or equivalent)
- 1x Galvanized steel washer: 1/2in
- 1x wire rope lanyard. 1/8in diameter, 12in long, galvanized steel, looped and crimped at both ends (McMaster part number 30645T101 or equivalent)



Figure 51 - Sentry Descent Weight

### Sentry Ascent Weights

Two *Sentry* ascent weights are used per dive. A single *Sentry* ascent weight is composed of:

- 3x or 4x Alvin plates depending on vehicle configuration
- 1x galvanized steel carriage bolt. 3.5in or 4in long depending on vehicle configuration. 1/2x13 thread. (McMaster part number 93604A721 or 93604A719 or equivalent)
- 1x galvanized steel washer, 1/2in (McMaster part number 98970A132 or equivalent)
- 1x or 2x galvanized steel hex nut. ½-13 thread. (McMaster part number 90371A045 or equivalent)



Figure 52 - Sentry Ascent Weight

### **Navigation Mooring Anchors**

One mooring anchor is used when the USBL system is calibrated and one mooring anchor is used per LBL transponder that is deployed. On the majority of cruises this results in the deployment of zero or one anchors during the duration of the cruise.

- 6x Alvin plates
- 1x Galvanized steel eyebolt with shoulder and nut: 6inX $\frac{1}{2}$ -13 thread (McMaster part number 3018T37 or equivalent)
- 1x galvanized steel washer, 1/2in (McMaster part number 98970A132 or equivalent)
- 1x or 2x galvanized steel hex nut.  $\frac{1}{2}$ -13 thread. (McMaster part number 90371A045 or equivalent)

## **Appendix I – Organization of Delivered Data**

*Sentry* cruise data has been organized in several different ways since the start of operations. Since January 2014, data has been organized generally as described below. However because we are continuously seeking improvement and because we often add custom systems, small additions or variations still occur, particularly in directories used for intermediate products.. Please contact us directly with any questions. Cruise data is organized into a number of directories. The top level directory structure contains the directories:

- Dives - All raw and processed data from individual dives
- Docs - Documents pertaining to the cruise such as launch positions and dive statistic summaries
- Planning - Files pertaining to mission planning. These are not generally needed by science
- Planning-bathy - This is the bathymetry provided by science for planning purposes
- Plots - Auto-generated plots from the post processing pipeline
- Products - The best at sea derived data products from the cruise
- Raw-usbl - Log and configuration files from the Sonardyne USBL system
- Svp - Sound velocity profiles used during the cruise

### **At-Sea Processed Data Products - Products Directory**

The products directory contains a directory for each dive in the format *sentry<xxx>*. Most data products include a time and date stamp in the file name. For images that is the time the image was taken, for all other products that is the time of the renavigation process and can be matched to other files created with the same navigation.

Within each dive directory the following directories are included:

- hf-sss - This directory contains data products generated from the 410kHz sidescan sonar system. Note that for a particular survey it is typical to have only HF or LF products, not both.
- lf-sss - This directory contains data products generated from the 120kHz sidescan sonar system. Note that for a particular survey it is typical to have only HF or LF products, not both.
- Multibeam - This directory contains the data products from *Sentry's* multibeam sonar including *grd* and *pdf* files. Most users will want to use the file
  - *sentryxxx\_yyyyymmdd\_hhmm\_nav\_tide\_xxx.grd* where X is the grid size. If *\verb=\_nav\_=* is included in the file name this means that *mbnavadjust* was applied. This is not common but if available these files are probably preferred to others.
- Photos - This directory contains thumbnails and movies of the photos collected by *Sentry*. Full resolution photos can be found in the dives directory.
- Sbp - This directory contains the products from the sub-bottom profiler.
- Scc - SCCs are 1Hz ASCII files containing post processed navigation and selected other science data. The timestamps on the SCCs can be matched to other data products. This flat ASCII file contains the date, time, latitude, longitude, depth, pressure, conductivity, temperature, optical backscatter, Nakamura redox probe (if available), and data from all three magnetometers (if installed). The file name contains both the dive number and the date on which the scc file was generated. If there are multiple scc files for a single dive, use the file with the most recent date. All fields in the scc file have been interpolated onto a 1 second time base. Users wanting to load the data into Matlab should use the mat files in the nav-sci directory.



### Raw and Intermediate Data - Dives Directory

The dives directory contains the raw and intermediate data for each dive. Within the dives directory there will be a directory for each dive labeled as n11k<xxx>. Typically there will also be a directory labeled pre-cruise that contains assorted data from tests conducted prior to the first dive.

Within each dive directory the following directories exist:

- multibeam
  - raw - raw s7k files
  - proc - all mbsystem files and inputs
  - ppl - vehicle navigation data
  - timing\_test (optional) - separate directory used to compute or check timing offsets if relevant
- nav-sci - This directory contains all of the navigation, science, and engineering data logged by the vehicle during the dive. Most of this data is provided for archival purposes only the scc files provide all standard sensor and vehicle navigation data. Users wishing to load data into Matlab, can use the mat files in /proc. The structure of this directory is:
  - nav-sci
    - proc
    - raw
      - acomm - log files from WHOI micro-modem if installed
      - topside-nav - topside tracking data
      - dvlsend - raw subsea dvl files
      - mc - mission controller files
      - subsea-nav - raw vehicle navigation data
      - rov - raw science sensor and engineering data in ASCII files
      - dvlnav - legacy topside tracking data - generally no longer present
- photos - We provide images in several formats with different levels of processing. These include the raw bayer encoded (color) tif files directly from the camera real-time software should users choose to reprocess those images. We also provide automated processing for color compensation and equalization. Filenames include date and time and can be used in conjunction with the SCC to obtain information on vehicle state and scientific sensors. The photos are stored in the following directory structure:
  - Presently, Sentry takes photos during the planned camera surveys and in the event that the dive ends with a photo survey, also during the ascent. Thus there will be photos of the water column.
  - photos
    - raw --- Bayer encoded original images (note that if the older camera is used these will be RGB encoded TIFF images)
    - proc - color corrected and smoothed color TIFF photos
    - movie - contains movies in .ogv and .mp4 formats and a all.kmz zip of all images and an index.html for a html based image viewer.
      - originals - a copy of the processed tiffs linked to the html viewer and making the movie directory a portable complete record.
      - Thumbs - reduced resolution jpegs of the processed photos used for the viewer making the movie directory fly-away
      - kmz - kmz files for google earth

- framemap - html frames for the html viewer
  - thumbs - reduced resolution jpgs of each processed image
- sss-sbp = All of the data from n11k's sub-bottom profiler and sidescan sonar
  - We provide the raw and processed Edgetech sonar data. These data are processed using commercial software 'SonarWiz5' developed by Cheasepeake Inc. into which the raw sonar files (.jsf) are imported. The software generates a project directory structure, associated files and populates the directories for each sonar data set processed. For each dive, there is a folder containing the raw data (jsf) files, the navigated data files and a SonarWiz project sub-directroy for each processed sonar (LF=120kHz, HF=420kHz, SBP=Chirp Subbottom).
  - The structure of this directory is:
    - sss-sbp
      - raw
      - navigated
      - lf
        - \*\*\* SonarWiz Project Directories \*\*\*
      - hf
        - \*\*\* SonarWiz Project Directories \*\*\*
      - sbp
        - \*\*\* SonarWiz Project Directories \*\*\*